

DYV1-10

# THE POWER OF GOLD

A Two-Round D&D LIVING GREYHAWK<sup>®</sup>

Dyvers Regional Adventure

Version 1

## ROUND 1

by Phil Thompson

While sometimes the life of an adventurer can be a tough one every once in a while it pays off. Today has been fantastic! Your hard work has finally paid off and you've been invited to a prestigious event. Life couldn't get any better than this. Perhaps fate has finally smiled upon you. Part two of the Kadoran series. An adventure for characters level 1-8.

DUNGEONS & DRAGONS, D&D, GREYHAWK and RPGA are registered trademarks of Wizards of the Coast, Inc. LIVING GREYHAWK is a trademark of Wizards of the Coast, Inc. Scenario detail copyright 2001 by Wizards of the Coast, Inc. ALL RIGHTS RESERVED. This scenario is intended for tournament use only and may not be reproduced without approval of the RPGA Network.

This is an RPGA® Network scenario for the Dungeons & Dragons® game. A four-hour time block has been allocated for each round of this scenario, but the actual playing time will be closer to three hours. The rest of the time is spent in preparation before game play, and scoring after the game. The following guidelines are here to help you with both the preparation and voting segment of the game. Read this page carefully so that you know and can communicate to your players the special aspects of playing an RPGA scenario.

## **PREPARATION**

First you should print this scenario. This scenario was created to support double-sided printing, but printing it single sided will work as well. There is enough room along the inside margin to bind the adventure, if you desire.

Read this entire adventure at least once before you run your game. Be sure to familiarize yourself with any special rules, spells, or equipment presented in the adventure. It may help to highlight particularly important passages.

When you run an RPGA D&D adventure we assume that you have access to the following books: the *Player's Handbook*, the *Dungeon Master's Guide*, and the *Monster Manual*. We also assume that you have a set of dice (at least one d4, d6, d8, d10, d12, and d20), some scrap paper, a pencil, an RPGA scoring packet, and your sense of fun. It is also a good idea to have a way to track movement during combat. This can be as simple as a pad of graph paper and a pencil, as handy as a vinyl grid map and chits, or as elaborate as resin dungeon walls and miniatures.

Instruct the players either to prepare their characters now, or wait until you read the introduction, depending on the requirements of the scenario as described in the introduction.

Keep in mind that you must have at least four players (not counting the DM), for the game session to be a sanctioned RPGA event. As well, you cannot have more than seven players participating in the game.

Once you are ready to play, it is handy to instruct each player to place a nametag in front of him or her. The tag should have the player's name at the bottom, and the character's name, race, and gender at the top. This makes it easier for the players (and the DM) to keep track of who is playing which character.

The players are free to use the game rules to learn about equipment and weapons their characters are carrying. That said, you as the DM can bar the use of even core rulebooks during certain times of play. For example, the players are not free to consult the *Dungeon Master's Guide* when confronted with a trap or hazard, or the *Monster Manual* when confronted with a monster.

Some of the text in this scenario is written so that you may present it as written to the players, while other text is for your eyes only. Text for the players will be in gray boxes. It's strongly recommended that you paraphrase the player text instead of reading it aloud. Some of this text is general and must be adapted to the specific situation or to actions of the player characters.

## **SCORING**

After the players have completed the scenario or the time allotted to run the scenario has run out, the players and DM score the game. The RPGA has three ways to score its games. Consult your convention coordinator to determine which method to use for this scenario:

1. No-vote scoring: The players write their names and RPGA numbers on the scoring packet grid. You fill in the top of the grid. That is all. No one is rated. This method is used for people who are just playing for fun.
2. Partial scoring: The players rate the game master and the scenario on their player voting sheet, and provide personal information, but don't vote for other players. The game master rates the scenario and completes personal and event information, but does not rate the players as a team or vote for players. This method is used when there is no competition, but the event coordinator wants information on how the game masters are performing, or the game master wants feedback on his or her own performance.
3. Voting: Players and game masters complete the entire packet, including voting for best player. If this method is used, be sure to allow about 15-20 minutes for the players to briefly describe their characters to the other players, and about 5-10 minutes for voting. This method is used when the players want to know who played the "best" among the group, or when the adventure is run in tournament format with winners and prizes.

When using voting, rank the players in order of your voting choice while they are completing their forms, so that you are not influenced by their comments on your abilities. It's a good idea to have the players vote while you determine treasure and experience awards for the scenario.

After voting, give the Scoring Packet to your event coordinator.

This is a LIVING GREYHAWK Adventure. As a Living™ adventure, it is expected that players will bring their own characters with them. If players do not have a LIVING GREYHAWK character generated, get a copy of the current LIVING GREYHAWK character generation guidelines, a character sheet, and a LIVING GREYHAWK log sheet from your convention coordinator or the RPGA Web site, and then have any players without a character create one. Once all players have a LIVING GREYHAWK character, play can begin.

Along with the other materials that you are assumed to have in order to run a D&D game, it is also recommended that you have a copy of the *LIVING GREYHAWK Gazetteer*.

## DETERMINING AVERAGE PARTY LEVEL (APL)

Because players bring their own characters to LIVING GREYHAWK games, this adventure's challenges are proportioned to the average character level of the PCs participating in the adventure. To determine the Average Party Level (APL):

- 1) Determine the character level for each PC participating in the adventure.
  - 2) If PCs bring animals that have been trained for combat (most likely war horses, dogs trained for war), other than those brought by virtue of a class ability (i.e., animal companions, familiars, paladin's mounts, etc.) use the following chart to determine the number of levels you add to the sum above. Add each character's animals separately. A single PC may only bring four or fewer animals of this type, and animals with different CRs are added separately.
- | CR          | 1 | 2 | 3 | 4 |
|-------------|---|---|---|---|
| 1/4 and 1/6 | 0 | 0 | 0 | 1 |
| 1/3 and 1/2 | 0 | 0 | 1 | 1 |
| 1           | 1 | 1 | 2 | 3 |
| 2           | 2 | 3 | 4 | 5 |
| 3           | 3 | 4 | 5 | 6 |
| 4           | 4 | 5 | 6 | 7 |
- 3) Sum the results of 1 and 2, and divide by the number of characters playing in the adventure—round up.
  - 4) If you are running a table of six PCs, add one to that average.

By following these four steps, you will have determined the APL. Throughout this adventure, APLs categorize the level of challenge the PCs will face. APLs are given in even-numbered increments. If the APL of your group falls on an odd number, ask them before the adventure begins whether they would like to play a harder or easier adventure. Based on their choice, use either the higher or the lower adjacent APL.

APL also affects the amount of experience you may gain at the end of an adventure. If your character is three character levels or more either higher or lower than the APL that this adventure is played at, that character will receive only half of the experience points

awarded for the adventure. This simulates the fact that either your character was not as challenged as normal, or relied on help by higher-level characters to reach the objectives.

**Note:** LIVING GREYHAWK adventures are designed for APL 2 and higher. Three or four, or sometimes even five 1<sup>st</sup>-level characters may find difficulty with the challenges in a LIVING GREYHAWK adventure. If your group is APL 1 there are three things that you can do to help even the score.

- 1) Attempt to create a table of six 1<sup>st</sup>-level characters, or try to enlist higher-level characters to play at that table.
- 2) Advise characters to buy riding dogs to help protect them, and fight for them. All riding dogs are considered trained to attack. PCs who want their dog to attack they must succeed at a Handle Animal or Charisma check (DC 10). Failure indicates that the animal will not attack that round. This is a free action (spoken command) that may be attempted each round. If an animal loses half or more hp in a single round it flees, unless another check is successful.
- 3) A group of APL 1 adventurers who desire an extra hand can "enlist an iconic." The stats for the 1<sup>st</sup>-level versions of Tordek, Miale, Lidda and Jozan are given at the end of each adventure. The group may pick one of these characters to joint them on this adventure. The DM controls that NPC.

If you are using a 591 CY adventure (campaign year 1) that uses the old Tiers, assume that the Tier multiplied by 2 is the APL suitable for that encounter.

## IS IT A FULL MOON?

Since the hazards of lycanthropy are a current part of the LIVING GREYHAWK campaign, it may be necessary to determine if this adventure takes place during a full moon. For game purposes, the full moon lasts three days of each month. For a given scenario that does not state the phase of the moon, roll 1d10 before play begins. On a result of 1, the first day of the scenario is a night of the full moon (roll 1d3 to determine where in the sequence of three nights it falls).

## LIFESTYLE

At the beginning of every scenario, each PC is required to pay upkeep costs matching the level of lifestyle they wish to maintain. The lifestyles, and the effects that each has on play, are:

**Destitute:** You have no living space, and must carry all your gear everywhere. You eat poor quality food. You wear a peasant outfit, your only change of clothes.

**Poor:** You sleep in poor accommodations, and eat poor quality food. You wear a peasant outfit, and have two sets of clothing.

**Common:** You have common lodgings, and eat common quality food. You have normal clothing for your profession (adventuring); nothing fancy. You probably have two or three sets of clothing.

**High:** You stay in good quality lodgings, and eat good quality food. You wear anything in value up to courtier's outfits, and generally buy a new set of clothing every two weeks.

**Luxury:** You have luxurious accommodations (twice the cost of good accommodations), and you eat excellent foods. You can throw a banquet for your friends every day, and frequently do. You wear clothing up to the value of noble's outfit, and buy a new set of clothes every week.

Lifestyles come with bonuses or penalties to Diplomacy, Intimidate, Disguise, and Bluff skill checks. These penalties, shown below, should be applied at the DM's discretion, and can sometimes backfire—for example, a PC with a poor lifestyle would not have a penalty when talking to a beggar, but would when talking to a city official. A PC with a high lifestyle should have a penalty when dealing with a group of street thugs, where a PC with a destitute lifestyle might not.

DMs are encouraged to role-play these reactions whenever possible.

Lifestyle Cost	Skill Modifier	
Destitute	14 sp	-2
Poor	43 sp	-1
Common	12 gp	0
High	250 gp	+1
Luxury	500 gp	+2

## ABOUT THE ADVENTURE

Rounds 1 and 2 of “The Power of Gold” ideally will be run back to back with the same group of adventurers. Unfortunately, due to life's unpredictability sometime this won't happen and there are instructions in the aftermath at the end of this round for how to deal with this.

## ADVENTURE SUMMARY AND BACKGROUND

Halston Jevin, an archaeologist from the free city of Greyhawk, is following a lead given by his research and has reason to believe the staff of Kadoran may have been lost on the island of Makilon. If he could recover the staff and excavate the ruins, the gold that would come from it would set him up for life. After parlaying with the Shadowind monastic order that lives on the island, he is

allowed to take a small team of his colleagues to excavate ruins found in a cave on the island.

Keeping the knowledge of the staff to himself, Jevin is operating the dig as a pure attempt to delve into the island's past. However, the cryptic clues to its whereabouts mentioned protector(s) that may still exist. Not the least bit interested in combating forces unknown, Jevin spent a modest sum promoting the reputation of several adventurers he had seen in Dyvers to a few of it's single affluent citizens in hopes that they would want to be seen with them. It would follow that they would invite the adventurers to go with them to an event on the island. The promotion was done through a couple of contacts Jevin knew from years past that ran in the same circles as the people Jevin needed to unknowingly recruit the adventurers.

Once on the island, Jevin would arrange to have the adventurers randomly “chosen” to get a tour of the dig. Earlier in the week his colleagues had come across a hidden door that led deeper into the ruins. Jevin wanted the adventurers on hand if trouble arose and ordered the dig to stop and catalog what had been taken and to make detailed maps of what had been discovered so far. Caught by the lure of the unknown, the archaeologists went ahead with the dig and disturbed the guardian(s) that slew them all shortly before Jevin and the adventurers arrived. Jevin does not know his colleagues are dead.

## ADVENTURE SYNOPSIS:

**Player Introduction**—The PCs are approached to accompany affluent Dyvers citizens to the island of Makilon. Halston Jevin, a Greyhawk archaeologist, has arranged for them to come to act as insurance in case his research into his archaeological dig proves true, and there is something guarding the dig.

**The Voyage**—Shortly after the Dyvers ship “The Top Line” launches into a light fog to transport the PCs to Makilon, a Dinosaur that was being transported breaks free. If the PCs make it to Makilon, they will be greeted at the monastery, and one of the order will free a slave; one of the passengers was bringing along.

**The Monastery**—Once on Makilon the PCs will be given a tour of the monastery and attend the Dyvers history book viewing. Later the PCs will be chosen to go to a dig on Makilon.

**The Journey**—The PCs encounter a storm along the way to the dig. They have the option of taking shelter (they will run into an encounter later if they choose this path) or to go ahead to the dig and risk becoming ill.

**The Dig**—At the dig Halston Jevin will go in first to let the other archaeologists know they have guests. Unbeknownst to Jevin, his peers have met the dig's protectors and have paid the ultimate price. When Jevin finds out what has happened, he goes into a coma from

shock shortly later (after begging the PCs to save his friends.)

**Exploring the Unknown**-If the PCs go into the dig, they will encounter the protector(s) and find the rest of the archaeologists that were slain by them. They also find other passages that are unexplored.

**This ends the round.**

**Appendix #1**-The Shadowind Order of Dyvers- This includes the order's history, benefits and membership requirements.

**Appendix #2**-The Order of the Crimson Heart- This includes the order's history, benefits and membership requirements

**DM's Handout #1**-A quick reference to keep track of what NPC is being escorted by a particular PC.

**DM's Handout #2**-A detailed reference of each NPC that the PCs escort.

**DM's Handout #3**-The Shadowind monastery floor by floor.

**DM's Handout #4**-The cave from Encounter #9.

**DM's Handout #5**-The Dig-This is a map of the dig on Makilon (This is the same as DM's Map #1 in Round #2)

**Player Handout #1**- This is the player's entry into the module.

**Player Handout #2**-Follow-up for Player Handout #1.

**Player Handout #3**- A follow-up handout for players that don't bite on Player Handout #1.

**Player Handout #4**-This is a drawing of the Shadowind monastery's unique building.

**Player Handout #5**-The Shadowind logo-This is what is tattooed on all the Shadowind order's monks.

**Player Handout #6**-The "Top Line" Topside.

**Player Handout #7**-The "Top Line" Lower deck 1.

**Player Handout #8**-The "Top Line" Lower Deck 2.

**Player Handout #9**-Halston Jevin's notes.

## PLAYER INTRODUCTION

The Player Characters (PCs) are accidentally mistaken for popular adventurers and invited to an exclusive event at

the mysterious Shadowind Monastery. Give Player Handout #1 to start with. If they agree, give them player handout #2. Should they not want to go with the NPC, then give them Player handout #3. A DM's handout #1 is included so the NPCs the PCs are escorting will be easier to keep track of.

## ENCOUNTER 1: BOARDING THE "TOP LINE"

*"Soon after alterations have been made and personal business has been taken care of, you meet your escort at the designated pier in the harbor. Before you is the "Top Line," an impressive medium-size galley. At the top of the boarding ramp stands a sea-worn human in regal sailing togs. Your escort informs you that this is Captain Esgrock and introduces you. The captain welcomes you aboard and advises you to stay clear of the tarp, although you may walk along the edge of the deck across from it. Once aboard, the crewman stow any luggage below deck (Player Handout #8) and you are relatively free to walk about. Aside from normal crewmen, there appear to be others dressed in a similar manner to you and your escort. Although there is a light fog, the ship will soon be under way.*

At this time the PCs may introduce themselves and they will recognize any other PCs they know.

If the PCs ask Captain Esgrock or his crew they can find out the following:

- Captain Esgrock has been sailing the Nyr Dyv for 12 years
- The voyage to Makilon (The island that the Shadowind Monastery is on) will take about an hour and a half
- The ship will then sail to Radagast in the County of Urnst to deliver its "Cargo."
- Stay clear of the large tarp. Although it is quiet now, a large sedated beast is secured and resting under it.
- The crew, while not being too thrilled about hauling the beast, trusts their captain to deliver it and them safely.
- This crew has been together five years.
- The odd-looking gentleman standing at the bow of the ship is a Crimson Knight. Why he is on board is anyone's guess. Usually a "People's Defender" keeps around the Dyvers slum quarters. He may be here to keep an eye on Palchas, a known slave trader whom is also on board. (Palchas is below deck in the aft-most guest room and will tell those that knock on his door to go away.)

Go to Encounter 2

## ENCOUNTER 2: ABOARD THE “TOP LINE”

The PCs are transported to the Shadowwind Order's island home via the Dyvers merchant galley “The Top Line.” The ship is en route to Radigast City in the County of Urnst and is fully laden with its cargo. Its passengers range from a poor soul working his passage off on the trip to the near opulent. Here and there are adventuring-looking individuals by the look of them. Perhaps the oddest thing topside is what appears to be a large beast that appears to be secured and covered with a large tarp. An attendant, a poor sod working off his passage by the looks of him, gingerly offers the beast a piece of raw meat on the end of a spear. Then without warning the beast stretches, and his hapless feeder accidentally pokes him with the spear. Roaring loudly, the beast tries to rise as ropes stretch and snap. Caught off guard, the crew readies attempts to ready their weapons as the beast looks with a baleful eye at his feeder and the merchant near him. It appears to be contemplating its dinner. Dismayed by the turn of events, Captain Esgrock will offer anyone that defends the beast free passage to anywhere the “Top Line” sails if they will defend the ship and it's persons aboard. The PCs will not have time to haggle if they wish to intercede before the dinosaur attacks.

The ship's decks and NPC positions are on Player Handout #6

### THE DINOSAUR ATTACKS!

The dinosaur is faced with a dilemma. It does not care at all for this ‘floating island,’ but does not wish to go into the Nyr Dyv. Faced with no options, it is content to take its revenge upon its captors.

Captain Esgrock has taken added precautions to protect his ship while delivering the beast and has 3 light crossbows stored in the bow of the ship below deck that crewmen #s 4 and 5 will go to retrieve. Unfortunately, they were doing their regular jobs when the beast freed itself and lose some time due to their being surprised. They will arrive on melee round three with an additional crewman to try and shoot the beast from the bow. 3 additional crewmen will arrive topside from the bow hatch armed with short swords and wooden shields. There are 3 light crossbows stored in the aft of the ship that crewmen #'s 1 and 3 will go to retrieve. As they were also surprised, they will arrive on melee round two with an additional crewman. Three additional crewmen will arrive topside from the stern hatch armed with short swords and wooden shields. (If the Dinosaur is threatening the hatch area then the crossbowmen and the swordsman will go to the next available non-threatened hatch. They can tell if it is threatening the hatch by the sounds of its movement above.) (All the crossbowmen will take the -4 penalty for shooting into melee.)

The captain will draw his short sword and try to rally his crew. His objectives will be to ...

- Contain the Dinosaur where it is.

- Assist efforts already under way (the crossbowmen will take the -4 penalty when firing into melee).
- Once the creature is downed they will try to restrain the beast and keep it alive. After all, it is valuable cargo.
- There is a critical events summary at the end of the module. Mark whether the Dinosaur lives or dies.

### APL 2 (EL 4)

☛ **Deinoychus, advanced 8HD** (1): CR 4; Large Beast; HD 8d10+24; hp 48, Init +2; Spd 60 ft., AC 16 (touch 11, flat-footed 14), Atk +10 melee (2d6+4, rake) and +6 melee (1d3+2, 2 claws), and +6 melee (2d4+2, bite); SQ Scent; Face/Reach 5 ft. by 5 ft./10 ft.; SV Fort +7, Ref +6, Will +2; Str 19, Dex 15, Con 17, Int 2, Wis 12, Cha 10.

*Skills:* Hide +7, Jump +13, Listen +11, Spot +11, Wilderness Lore +9.

### APL 4 (EL 6)

☛ **Megaraptor** (1): hp 76; see *Monster Manual* page 55.

### APL 6 (EL 8)

☛ **Megaraptor, advanced 15 HD** (1): CR 8; Huge Beast; HD 15d10+60; hp 135; Init +2; Spd 60 ft.; AC 16 (touch 10, flat-footed 16); Atk +16 melee (2d8+5, rake) and +11 melee (1d4+2, 2 claws) and +11 melee (2d6+2, bite); SQ Scent; Face/Reach 10 ft. by 10 ft./15 ft.; SV Fort +10; Ref +8, Will +4; Str 21, Dex 15, Con 19, Int 2, Wis 15, Cha 10.

*Skills:* Hide +5; Jump +19; Listen +12, Spot +12, Wilderness Lore +10.

### APL 8 (EL 10)

☛ **Megaraptor, advanced 20 HD** (1): CR 10; Gargantuan Beast; HD 20d10+120; hp 220; Init +2; Spd 60 ft.; AC 18 (touch 8, flat-footed 18); Atk +25 melee (2d12+9, rake) and +20 melee (1d6+4, 2 claws) and +20 melee (2d8+4, bite); SQ Scent; Face/Reach 10 ft. by 10 ft./15 ft.; SV Fort +10; Ref +8, Will +4; Str 29, Dex 15, Con 23, Int 2, Wis 15, Cha 10.

*Skills:* Hide +4; Jump +24; Listen +12, Spot +12, Wilderness Lore +10.

**Note:** If the Dinosaur is reduced to 10 or fewer hit points, it will be weak enough that four crewman, adventurers, or a combination of both will be able to restrain it with ropes to tie it down.

The deck is too small and uneven for the Dinosaur to charge.

If there are PCs and a ship left, go to Encounter 3.

### THE CREW

☛ **Captain Esgrock, Fighter, male human F4** (1): Medium-size humanoid (human), HD 4d10 hp 28, Init +2 (Dex),

Speed 30 ft., AC 12 (touch 12, flat-footed 10), Atk 1 melee +4 (1d6/18-20, scimitar), or +2 ranged., AL LN; SV Fort+4, Ref +5, Will +1; Str 10, Dex 14, Con 10, Int 14, Wis 10, Char 15.

*Skills and Feats:* Climb +7, Profession (Sailor) +7, Swim +7, Use Rope +9; Blind Fighting, Combat Reflexes, Dodge, and Lightning Reflexes

*Possession:* Captain's clothes, Leather boots, Scimitar, Dagger and a pouch with 22 gp.

Captain Esgrock is listed as #10 on Player Handout #6.

Captain Esgrock has been sailing the Nyr Dyv for 12 years. His great-grandfather was an orc. This is not common knowledge, and his orc lineage is not apparent. Esgrock is named after his father and grandfather but quit referring to himself as Esgrock III before sailing the Nyr Dyv.

The crew has generic stats listed below. The human males, Marik, Aslan, Zalor and Korin are numbers 2, 4, 5 and 11 on Player Handout #6. Human males Tason, Jimic, Normid, Walsh, Elger, Yarmon, Talsh and Jenkin are below deck.

The human females Shiela, Vera and Zoe are numbers 1, 6 and 9 on player handout #5. Human females Lauria, Eilissa, Dashalla and Trella are below deck.

#### ☞ **Crew Members, mix male (4) and female (3) humans**

**Ftr1:** CR 1; Medium-size humanoid (human); HD 1d10; hp 5; Init +0; Spd 30 ft.; AC 12 (touch 10, flat-footed 12), Atk +2 melee (1d6+1/19-20, short sword), +1 ranged (1d8/19-20, light crossbow); AL LN; SV Fort+0, Ref +5, Will +0; Str 12, Dex 13, Con 11, Int 10, Wis 12, Cha 10.

*Skills and Feats:* Climb +5, Profession (sailor) +4, Swim +5, Use Rope +4; Dodge, Mobility

*Possessions:* Leather armor, short sword, and dagger.

Captain Esgrock's crew has been with him for five years and is extremely loyal.

#### ☞ **Azuron The Dinosaur Feeder, male Human Ftr1:**

CR 1; Medium-size humanoid (human); HD 1d10; hp 5; Init +0; Spd 30 ft.; AC 12 (touch 10, flat-footed 12), Atk +2 melee (1d6+1/19-20, short sword), +1 ranged (1d8/19-20, light crossbow); AL LN; SV Fort+0, Ref +5, Will +0; Str 12, Dex 13, Con 11, Int 10, Wis 12, Cha 10.

*Skills and Feats:* Climb +5, Profession (sailor) +4, Swim +5, Use Rope +4; Dodge, Mobility

*Possessions:* Leather armor, short sword, and dagger.

Azuron fell on hard times and is working his way to the County of Urnst to live with relatives. Azuron is #7 on Player's Handout #2.

#### ☞ **Devon, Knight of the Crimson Heart, male human**

**Ftr3:** CR 3; Medium-size humanoid (human); HD 3d10; hp 11; Init +0, Speed 30 ft, AC 17 (touch 12, flat-footed 15); Atk +5 melee (1d8+2/19-20, longsword); AL LN; SV Fort+5, Ref +5, Will +2; Str 14 Dex 14 Con 10 Int 10 Wis14 Cha 10.

*Skills and Feats:* Diplomacy +4, Handle Animal +4, Gather Information +2, Search +2; Cleave, Combat Reflexes, Power Attack.

*Possessions:* Chain shirt, small steel shield, longsword.

Devon is #3 on Player Handout #6.

Devon has been keeping an eye on Palchas for a while. He is hoping that Palchas will be bold enough to walk off the "Top Line" on to Makilon. If not, perhaps he could fall off the ship near the dock. He plans to get off in Makilon and catch a ship back later that day.

## ENCOUNTER 3: FREE AT LAST!

*Soon the galley docks at Makilon Island, passengers disembark and it feels good to have solid ground under your feet again. One of the passengers, a slave owner by the looks of his possession, is about to leave when Captain Esgrock stops him and appears to give a warning. The passenger seems to want none of it and walks off the ship. As soon as he and his companion set foot on the dock, several monks surround them.*

*"Do you lay claim to this person?" One of the monks, apparently the leader, speaks.*

*"W-why yes, I bought him near Dyvers. What seems to be the problem?" The merchant says hesitantly.*

*"All that set foot on Shadowind soil are free souls. You have no claim to him here. Your captain tried to warn you as such," the monk says matter of factly.*

*"This is an outrage!" The merchant bellows. "I have all the proper papers and..."*

*"Which do not mean anything here except that you are a blot on civilization for having the contempt of life to buy and sell people. I would suggest that you stay on board until your ship departs. You are not welcome on Makilon," the monk says sternly.*

*Obviously beaten and not at all used to such troubles the merchant slinks back up to the "Top Line." Once safely aboard, he leans over the edge, takes a long look at the people on the dock and yells, "You've not heard the last of this. I have powerful friends that will see to it that my property is recovered!"*

*"If this happens they will be dealt with. If they also have slaves with them, then we will have more liberated souls on the island," the monk says calmly as if used to such threats. Then he turns to you and speaks. "I'm sorry for such matters, but some things need dealt with expediently. I am Arzach. Welcome to Makilon. I will take you to the monastery and show you to your quarters."*

Go to Encounter #4.

## ENCOUNTER 4: THE MONASTERY

*Traveling along a lush path through a cultivated area of beautiful irises, you marvel in the beauty of Makilon. In a short time you reach the monastery. The building itself appears to be*

ancient (those with stone masonry or a like skill can make a DC of 27 to see where the building has been restored.) and of different craftsmanship than those in Dyvers. The stones were crafted to look like fish scales and reflect light like the inside of a seashell. Part of the walkway around the building bears the likeness of a giant squid. Where the squid touches the corners of the building, tentacles rise along the edge of the building, entwine themselves in pairs, and wrap themselves around the building as if it was trying to pull it into the earth. Reading your faces, Arzach speaks, "Beautiful isn't it? When our order was shipwrecked here, we were fortunate to be blessed with such a home. For some time now masons from the Dyvers Cement and Stone Company have been painstakingly restoring the building to it's former glory (Give out Player Handout #4). Further in the island a group of archeologists are assisting in the exploration of an even older set of underground structures. Once we are sure that we will not accidentally destroy relics from an older age, we will be able to use it to store delicate works.

From the garden, Arzach walks you to a large set of double doors in the monastery. He stops, bows and makes a deft motion with his right hand. Slowly the doors open into a wide hall lined with 5 monks on each side. As you enter, they bow as you pass. Behind you they rise and close the door. On the walls are frescos of strange amphibian (Kuo-Toa) humanoids being driven into the Nyr Dyv by tanned humans with spears. "These were recently restored," Arzach explains. "Where possible, we have tried to preserve what we've discovered. The archaeologists from Greyhawk have aided us greatly in our efforts."

"But I digress. Here are your rooms. Take a few minutes to make yourself at home and I will come back to give you a tour of the monastery. Dinner will be in three hours."

Go to Encounter #4A.

## ENCOUNTER 4A: EXPLORING THE MONASTERY

With Arzach as their guide, the PCs will be given ample time to explore the monastery. Arzach will take them around the grounds, first pointing out the stained glass windows in the upper east and west walls. To the north are fields in which the monks grow food to sustain themselves. The monastery faces the south. The dock the PCs came from is south of the monastery. Once the tour of the grounds is complete, the PCs will tour the inside starting with the martial training area, which is straight ahead from the monastery's front doors.

As the PCs are inside the monastery and are heading toward the martial training area, read the following:

*From the far end of the hallway you hear shouts and a great deal of commotion. Seemingly at home with the noise, your guide takes you down the sloping hallway and opens oaken double doors to a large training area, where close to a dozen monks work on their martial skills. Off to the left, a couple of monks carefully climb the east wall. To the right, four others mirror their mentor's moves as he practices with them. Ahead, a pair of monks watch as a third spars with another monk wielding a boken (wooden sword). As you enter, Arzach explains that this is*

*where the Shadowwind Order members may hone their skills. They have been expecting visitors, and the PCs may feel free to speak with them.*

- If the monks on the east wall (Rohland and Danthas, both human males) are spoken to, they will stop climbing and fall gracefully 18 feet down to the floor. They will explain that the fall was what they were primarily practicing. Some in their order can fall great distances without harming themselves.
- If asked, the mentor (Master Kirahn, human male) will stop and explain that the discipline they (Shasa, Mollicent, and Janise-female humans plus Conner and Olson-human males) are practicing is the walk of the legendary Shadow dragon. This "walk" contains the fluid motion of all the Shadowwind martial art stances.
- If asked, the monks (Arania-human female, Bereck and Taljas-human males) will stop sparring and talk with the PCs about stunning opponents.

There are stairs on the north wall that leads to a patio outside.

When the PCs are done, go to Encounter 4b.

## ENCOUNTER 4B: THE CALLIGRAPHY STUDIO

The door opens to a narrow room with 4 long tables. Six monks sit at various spots in the room as one monk sits at an elevated desk. Shortly after the door opens, the monk at the desk rises and clears his throat. All the other monks rise as the first one to rise introduces herself as Bashalla. They have been working on what appear to be small rectangular wooden blocks. Each monk has small supplies of gold leaf, ink, and a supple animal hide to work with as well as hammers, files, and calligrapher's tools. If the PCs look, those who can read will notice that the monks have been working on name plaques to place in the blocks. Sketched out on the animal hide are the PCs names. One name is with each monk. They will explain that these are for use at tonight's dinner. The PCs are told they may keep them after the book viewing.

Go to Encounter 4c.

## ENCOUNTER 4C: THE LIBRARY

After going downstairs, Arzach leads you to a large room. The west wall is lined with books of various sizes. The north wall has a large case with beautifully calligraphed books on display. The east wall has a large glass dome, under which appears to be an ancient book that looks



very fragile. Arzach will explain that this was found in the monastery and has yet to be undeciphered. It has been put on display mostly out of respect for its antiquity, for they are afraid if they move it the book will crumble. (The book was written in ancient Kuo-Toa by the mage Hasiloch. The book is open to the title page. Anyone speaking Kuo-Toa can read it. The Title page reads “Views of the Watery World. By Hasiloch.” The monks will not allow the book’s pages to be turned for fear they will break and crumble. The book has a slight magical aura. Upon a successful Spellcraft check it can be determined that it is from the enchantment school (DC 22). The monks do not wish any spells to be cast on the book because of this. The south wall has an empty case. This is for the monastery’s copy of the Dyvers, history book after the ceremony, Arzach says.

Go to Encounter 4d.

## ENCOUNTER 4D: THE ASSEMBLY HALL

*The assembly hall is in the top floor of the monastery. Two large stained glass windows dominate the roof. The windows in the east depict a large shadow dragon in a spring setting. The one in the west depicts a large shadow dragon in a winter setting. It is evident if anyone speaks that the acoustics are superior here. Arzach mentions that dinner will be served shortly. You are seated at a large table in the modest hall. At several other tables sit the other invited guests and the members of the monastery who are not involved with preparing and serving the meal. You are told that at the far end of the middle table sits the head of the order, Master T’quan. As dinner winds down, Master T’quan will clear his throat, and all the Shadowind monks will fall silent. He rises and goes toward a podium as 4 monks carry in a large silk-covered object on two poles and set it on a table in front of the podium. Master T’quan pauses for a moment and speaks.*

*“We have been blessed with the opportunity to flourish in the face of adversity. As we sought to live in peace on Makilon, we had the gift of being able to help others who had washed up on our shore. Fortunately, a rescue ship came and took them home to their loved ones.*

*Soon more ships came to visit, and we opened diplomatic relation with Dyvers. With their help, we were able to replenish supplies that we couldn’t find here on the island. Because of this, we are gathered here today.”*

*Master T’quan pauses as the silk is removed to reveal two huge books. “Before you is the fruit of our labors. These identical books contain the known history of Dyvers. One is to be put on permanent display here in the monastery, and the other is to be delivered to Dyvers. Tonight, for the first and only time, the books will be on display together here in the monastery.”*

*After speaking, Master T’quan steps away from the podium, and several attending monks come over to escort your table to view the books.*

The PCs will be given the chance to look at the book for some time. The PCs will receive certs that gives them a +1

circumstance bonus to Knowledge (local-Dyvers) skill checks at the end of the module.

*After all the tables have been escorted in turn to view the books, Master T’quan steps back to the podium to address the gathering. “We are honored to have you as our guests, especially at this most exciting time in our history. Tonight we are also joined by Halston Jevin, an archeologist from the excavation. I believe he has an announcement to make.” Master T’quan motions to Halston Jevin and sits.*

*“Thank you for your hospitality, Master T’quan. As I’m sure everyone knows by now, we are conducting a dig further in the island. Because of the risk of disturbing it, we cannot risk bringing everyone there until it is completed. However, we would like to invite a few of you to see what we’ve excavated so far. If you look under your seats, you may find a blue piece of silk. Those who do will be invited to tour the dig this evening.”*

*With modest excitement, all the guests around you check the bottom of the chairs. Alas, only your group (The PCs) seems to come up with blue silk. Although they won’t be going, your escorts seem happy that you were more fortunate.*

*Looking over the crowd, Halston Jevin speaks. “Those who have the blue silk may tour the dig tomorrow. Will you join us?” He asks the PCs.*

At this point ask the player’s if they accept. Those who don’t will be given passage off the island in the morning. Give the player a chance to reconsider if they do not choose to go to the dig. The adventure ends for those who do not go.

**Note:** The escorts will not change places with the PCs, because they wouldn’t think of depriving them of the fun.

*Jevin looks pleased as he addresses the crowd. “Excellent, I know you’ll enjoy the dig. And don’t fret if you didn’t get a chance to go. The exhibit will be on display in Dyvers after the dig is completed. But we have a busy day ahead of us tomorrow, and I am turning in for the night. The “Endeavor” should be here in the morning for those who will not be joining me. I bid you good night and good travels tomorrow!”*

*Jevin excuses himself and thanks Master T’quan for his hospitality. Shortly after, the monks start clearing the room and prepare to rest for the night.*

As they work, they will ask if the PCs need anything before they turn in and will escort them to their rooms if they wish.

It should be noted that PCs roaming the monastery after hours will be frowned upon. Any PCs roaming the monastery will be met by a pair of monks, who will politely ask what they need and suggest that they retire for the evening as tomorrow’s journey will be on foot and a will probably be a vigorous walk.

Once the evening is over the PCs will be shown to their rooms. In the morning their escorts, Devon (If he survived the Dinosaur attack.), the monks that are scheduled to return to Dyvers and the dignitaries from Dyvers (whom arrived on a different ship.) that were in

attendance will be sailing back home on the Dyvers ship the “Endeavor.”

*After a sound night’s sleep, the sounds of the monastery rising to meet the day awaken you. In short order, a monk knocks on your door and escorts you to a hearty breakfast. Seated at your table are Master T’quan and Halston Jevin, the archaeologist from Greyhawk. As you finish, Jevin rises and begins to speak, but stops as a monk comes in to inform all that the Endeavor has docked, finished preparations, and will be ready to take on passengers shortly. Master T’quan thanks him and suggests that the ship should not be kept waiting. Soon those that are not staying for the dig, and quite a few of the monks that are scheduled to work in the Scribe’s Guild in Dyvers, prepare to leave. All but a few of the remaining monks go to wish them well. Your friends tell you that they would like you to see them off.*

If the PCs go to see their escorts off read the following...

*With a fond farewell, your new friends bid adieu. Your company was something that they will always remember, and were it not for pressing obligations they would love to stay and hear of your tour of the dig. As the “Endeavor” pulls away from the dock, they wave and wish you the best of luck in all your travels. As the ship sails off, Halston Jevin speaks.*

*“It pleases both myself and Master T’quan that you have accepted the opportunity to visit the dig. As in accordance to our agreement with the Shadowwind Order, we will be traveling on foot, as wagons and horses are used sparingly here to preserve the land’s natural beauty. After the dig, Master T’quan would like us to visit a special garden the monks tend.*

*We will leave for the dig in half an hour. Please take a moment to prepare yourselves for the journey. We should reach the dig later this evening.*

Go to encounter #5.

## ENCOUNTER 5: STORM FRONT

*Your guide is very talkative and shows you the sights of the Makilon as you travel. Once you are out of sight of the monastery, it is obvious how much care has been taken by the order to protect the island’s ecosystem. As you stop for lunch, Jevin looks up into the noon sky. “My, I hadn’t noticed how dark the sky is growing! Perhaps we should see the garden first. There is shelter near there, and it is closer than the dig or the monastery.” As he speaks, drops of rain begin to fall.*

If the PCs take Jevin’s advice, go to Encounter 6.

If the PCs decide to go on in the rain go to Encounter 7.

## ENCOUNTER 6: SHELTER FROM THE STORM

*As you travel toward shelter, the light rain stops. With a just a hint of excitement, Jevin, your guide, tells you about the dig on Makilon. From what they’ve surmised, the excavation pre-dates the monastery by at least 900 years. They’ve had several exciting finds so far and have been quite pleased with how the monks are handling this. Thus far, the archaeologists been approved to show their finds in several cities to help cover the cost of the excavation. The monastery has allowed them to keep several pieces outright, requiring that they be cataloged and sketched first. Proudly, Jevin pats his vest pocket and tells you that he has been keeping a record of the dig for a report he hopes to give in Greyhawk once the dig is finished.*

*When you break for dinner, Jevin apologizes for rambling and comments about the sky growing cloudy overhead. The Shadowwind Order would have his head, and the monks would be very displeased, if you were to become ill due to the elements. He is glad that you’re stopping for shelter.*

Go to Encounter 8.

## ENCOUNTER 7: CHILLS AND SNIFFLES

If the PCs insist on traveling, Jevin will pull his cloak tighter around him, mutter for a moment, and take them to the dig. The trip will take 4 hours in the quickening storm. The PCs and Jevin must make a Fort save every hour (DC 13 for the first hour, DC14 for the second hour, DC15 for the third hour and DC 17 for the third hour) or catch a cold. Each failed save give the PC a cumulative –1 to actions due to catching a cold. The effects will last until the PC has 3 days rest in bed.

From here the PCs may go back to the monastery, go to the cave (Encounter 8), or go to the Dig (Encounter 12).

## ENCOUNTER 8: THE CAVE

As you travel on, the skies darken and grow swollen, but before they break open you see what appears to be the mouth of a cave up ahead. Jevin tells you that the Shadowwind Order uses this area to conduct botany experiments and would prefer that we keep on the marked path at least until morning. Almost in answer to this, a massive thunderclap rips overhead, and lightning apparently hits somewhere close as a blinding flash of light follows quickly. Jevin recovers after being momentarily dazed and shows you to a series of bunks, then excuses himself to go start a fire.

*“We should be fine for the night,” he says as the rain begins to fall anew.*

Go to Encounter 9.

## ENCOUNTER 9: THINGS THAT GO BUMP IN THE NIGHT

Have the party set up watch. On the first watch, no one sleeps well as thunder and lightning crash through the night. People on watch during the early evening will see (a) vague shape(s) in the flashes but will not be able to make out anything definite. The vague shape(s) is a/are Manticore (s) (Tier's 1-3. Tier 4 it is a Chimera), that has been temporarily grounded by the storm.

If Halston Jevin dies, the PCs have been told roughly where the dig is and can find it

People on watch after midnight will encounter the monsters

### APL 2 (EL 4)

This unicorn has been wounded by a thunder strike. The electrical shock has put it in a rage, and it will strike out at any PC it can in its last moments.

➤ **Manticore** (1): hp 57 (currently 15), See *Monster Manual* page 130.

### APL 4 (EL 6)

➤ **Manticore, advanced 9 HD**: CR 6: Huge magical beast; HD 9d10+40; hp 88; Init +2; Spd 30 ft., fly 50 ft. (clumsy); AC 16 (touch 10, flat-footed 14); Atk +12 melee (2d4+5, 2 claws) and +10 melee (1d8+2, bite), or +9 ranged (1d8+2 6 spikes); SA Spikes; SQ Scent; Face/Reach 10 ft. by 20 ft./10 ft.; SV Fort +9, Ref +7, Will +3; Str 20; Dex 15; Con 19; Int 7; Wis 12; Cha 9.

*Skills and Feats*: Listen +11, Spot +12\*; Multiattack, Power Attack.

**Spikes (Ex)**: With a snap of its tail, a manticore can loose a volley of size spikes ass a standard action. This attack has a range of 180 feet with no range increment. A spike threatens a critical hit on a natural attack roll of 19 or 20. The creature can launch only twenty-four spikes in a single day.

**Skills**: \*Manticores receive a +4 racial bonus to Spot checks in daylight.

### APL 6 (EL 8)

➤ **Manticore, advanced 9 HD** (2): hp 90, 88; see above.

### APL 6 (EL 8)

➤ **Chimera (blue dragon head)** (3): hp 87, 80, 76; see above.

➤ **Halston Jevin, male human, Rogr**: CR 1; Medium-size Humanoid (human), HD 3d6; hp 14, Init +7; Speed 30 ft, AC 13 (touch 13, flat-footed 0); Atk +0 melee (1d4/19-20, dagger); AL CG, SA: NA, SD: NA, SV Fort+0, Ref +5, Will +0; Str 10 Dex 16 Con 10 Int 14 Wis 14 Cha 10

*Skills and Feats*: Appraise +6, Bluff +4, Climb +4, Diplomacy +4, Decipher Script +6, Forgery +6, Hide +7, Knowledge (local-Dyvers), +2, Knowledge (architecture) +2, Use Rope +7; Improved Initiative, Dodge.

*Possessions*: Dagger, 3 days rations, journal

Halston Jevin was a small-time rogue a long time ago. He used his modest thefts from the rich to learn about archaeology and found out about the staff of Kadoran.

Go to Encounter 10

## ENCOUNTER 10: DAWN'S EARLY LIGHT

If the PCs survive the night they find the rain tapers off about 4am and stops at 5am, giving way to a beautiful sunrise. As they get ready for the day, they will be surprised by an odd sneezing sound from the back of the cave up near the ledge. This will be followed by a quick "Pardon me" in an antiquated but understandable common dialect.

The sneezer is a Pseudo Dragon by the name of Pasha. She has been watching the PCs for a while and might possibly consider traveling with one of them, although she will never admit this outright. Her preferences from the PCs are as follows...

Sorcerers 6 points  
Wizards 5 points  
Clerics 4 points  
(Weejas Clerics 2 Points)  
Monks 3 points  
Fighters 2 points  
Rogues 1 point  
Paladins 0 points

Roll a d20. Add the points for their class as listed above, and add in their charisma modifier. The PC with the highest score is the one Pasha might travel with. To gain the pseudo-dragon's trust, the PC must feed and lavish attention on her (letting her ride on their shoulder or preferably carrying her, protecting her from harm, making a bed for her when the party stops for the night etc.

**Note**: The PC does not have to do all this. These are but examples. Basically, Pasha craves the attention somewhere between what one would bestow on a cherished family pet and a loved one.). Pasha will also inform the PC she is traveling with that she must return to Makilon from time to time because she will miss it. (4 time units per year. If this isn't done, she will leave the PC for good and return under her own power to Makilon.) . Pasha is very fond of the mushrooms (The non-magical variety. The magical ones give her indigestion) that are found in Encounter #11.

Go to Encounter 11.

## ENCOUNTER 11: THE MUSHROOM PATCH

**Note:** There are only enough mushrooms here to give each PC one. If they come back later or in round two there will be no more that are ready

In the morning, Jevin and Pasha (if she is traveling with the PCs.) will go to the Shadowind mushroom patch. Over time, the monks have been crossbreeding these plants to enhance their medicinal powers. They have instructed Jevin to let each PC have one mushroom as a token of their visit. Each special mushroom, when eaten, has the power of a *neutralize poison* spell cast as a 5<sup>th</sup>-level druid. The mushrooms that Pasha craves are on the south edge of the patch and are not in the monks' tended area.

Go to Encounter 12.

## ENCOUNTER 12: THE DIG

After a day's travel, your guide slows down a bit before a small cave with fresh dirt on the ground in front of the entrance. "Here we are. Beautiful, isn't it? If you would please wait for me here while I let the workers know that we are here, so it won't be a surprise to them when you tour the dig.

**Note:** If the PCs insist on not waiting, Jevin will become slightly upset at their bad manners. He will politely explain that the archaeologists working the dig are more used to dusty bones than living people, and while it must be hard to wait he would really appreciate their patience.

Go to Encounter #13.

## ENCOUNTER 13: WHEN THE TROUBLE STARTS

*Jevin disappears into the mouth of the cave, and you bask for a moment in the beauty of the island. It would be easy to get lost here and not care. How the archeologists could spend most of their time in the dig and not outside is surprising to you. Then, just as you're about to relax, a scream echoes from below, and you hear something coming your way.*

*A very shaken and scared Halston Jevin emerges from the cave entrance. His eyes are white with fear, and his clothes are drenched with sweat. "My friends! They're down there! You have to help them!" As he blurts this out, you notice Jevin seems to find it more difficult to breathe. Slowly, he slumps to the ground. As he lies on the ground, a whisper trickles from his lips. "Please help my friends. I was looking for the fabled staff of Kadoran that I thought might be here. I knew there might be trouble, but I didn't imagine anything like this would happen. I'm so sorry. Please, (cough) my friends," Jevin coughs once more and then*

*doesn't worry about anything ever again as the light fades from his eyes.*

Halston Jevin has gone into a deathlike coma. If the PCs make a search check at DC 29, they will be able to tell he is still alive. If the PCs take him back to the monastery, the monks will care for him. Recovery will take several months.

If the PCs search Jevin, they will find Player Handout 9.

If the PCs go in to rescue the archaeologists, go to Encounter 14.

The PCs may also go back to the monastery and report what happened. If so, go to Encounter 15.

If the PCs go to where Jevin is, they will see the inside of the cave with a passage on the far wall going down.

*The cave before you is lined with provisions and a few excavating tools. 10 feet into the cave, the wall turns into tooled stonework that is similar to the interior stonework of the Shadowind monastery. To the right up ahead of you is a passage that leads down.*

## ENCOUNTER 14: EXPLORING THE UNKNOWN (ROOM 1 OF THE DIG)

*As you enter from the cave above, you notice that there are parts of broken digging tools, cots, and crates all over the room. The walls are splattered with blood and bits of hair and skin. In stark contrast to the carnage, each wall bears a continuous fresco of water creatures (frogs, fish snakes and turtles living in harmony with each other). There is a door in the west wall.*

This ends round 1 unless the PCs wish to report the tragedy to the monastery

If the PCs wish to go back to the monastery, go to Encounter 15.

## ENCOUNTER 15: REPORTING BACK TO THE MONASTERY

The PCs may decide to report back to the monastery. If so, Master T'quan will be very concerned about what has happened. He will tell the PCs that he appreciates them reporting this, and that honor dictates that the PCs have the privilege of the rescue. If the PCs have pressing obligations or feel that they are out of their league, then of course the monastery will step in to remove the threat when those that are in Dyvers return.

While disappointed in Halston Jevin's motives, Master T'quan would prefer that they tend to the archaeologist instead of sending him to Dyvers when he stabilizes. If the PCs bring Jevin back, they will be thanked for it.

At this point the players can do a couple of things:

1. Continue to explore the dig. (This will happen in round #2).
2. Return to the monastery and report what has happened. This can result in a couple of options. The Shadowind Order will allow the PCs the honor of exploring if they agree to report what they find so it may be cataloged and to handle any artifacts with care.

Any PC monks will be expected to help out with the situation, but will not be obliged to do so. Any PC Shadowind monk who leaves instead of going to round two will lose face in the order and may not advance in the order for 6 months of real time (If this happens send an email with the heading "The Power of Gold-Shadowind." Include the player's name, their character's name, the convention coordinator's name and email address to [jcts@iland.net](mailto:jcts@iland.net)). Non-Shadowind monks who do not go on to round #2 will not be asked to join the order, but may join later and suffer no blot on their record.

They may return home, and the monks will deal with the problem when more of their order returns. Currently, they are at a light staff and must be ready to defend the monastery in case slavers set foot on the island.

## The End

# EXPERIENCE POINT SUMMARY

To award experience for this adventure, add up the values for the objectives accomplished. Then assign the discretionary roleplaying experience award. The roleplaying award should be given for consistent character portrayal and contribution to the fun of the game. You can award different roleplaying amounts to different characters.

Award the total value (objectives plus roleplaying) to each character.

### Encounter 2

Defeating or subduing the Dinosaur 200 xp

### Encounter 9

Defeating the Manticore(s) or Chimeras 200 xp

### Encounter 10

Convincing Pasha to come along with the you 50 xp

Total experience for objectives 450 xp

Discretionary roleplaying award 0-50 xp

**Total possible experience 500 xp**

# TREASURE SUMMARY

Player characters may keep items from the scenario that are listed on the treasure list below or which meet the following conditions:

1. The item must be non-magical and specifically listed in the text of the adventure (e.g. armor on foes). If it is not listed in the text, the characters cannot keep it. Items of this nature can be sold for 50% of book value, or recorded on a log sheet.
2. Animals, followers, monsters, henchmen, and so forth (any living being, basically) may not be kept from a scenario for any reason unless the treasure summary lists the being specifically. It is okay for the player characters to form relationships with NPCs, but these will not be certified and cannot bring material benefit to the character. Contacts (sources of extra information) must be specifically certified.
3. Theft is against the law, but may be practiced by some player characters. Items that are worth more than 250 gp that are of personal significance to the owner (including family heirlooms), and all magical items, will be discovered in the possession of the character by one means or another. The character must return the item and pay a fine equal to three times the value of the item stolen. In addition, the PC caught receives campaign-decided penalties for being known as a thief. For other stolen items which meet the criteria in #1 above, use your judgment and the circumstances within the game to determine whether a PC thief gets away with the theft or not.

Any item retained according to these rules, which does not have a certificate, will not ever have a certificate issued for it.

The campaign staff reserves the right to take away any item or gold acquired for things that it later finds unreasonable but which were allowed at the time.

### Encounter One

From the Player Introduction

- Two suits of fine clothing (per PC) 25gp each

### Encounter 4d

- Each of the PCs will receive a finely scripted card that serves as a nameplate for dinner at the Shadowind monastery table. The card may be presented to give a +4 circumstance bonus to a single future Gather Information DC roll.

### Encounter 4e

Each PC who declares that they would like to take a look at the Dyvers History book will receive a +1 bonus to Knowledge (Dyvers history) skill checks. This stacks with other bonuses Non-tradable

**Encounter 10: Dawn's Early Light**

If the PCs pay Pasha the pseudo-dragon enough attention and agree to bring her back to Makilon, then Pasha promises to return a favor. Pasha promises to, sometime in the future, serve as a familiar if the PC so chooses to take him. In order to gain Pasha as a familiar the character must take the Improved Familiar feat found in *Tome and Blood: A Guidebook to Sorcerers and Wizards*.

**Encounter 11: The Mushroom Patch**

Each PC receives a Mushroom that, if eaten, has the effect of a *neutralize poison* as cast by a 5<sup>th</sup>-level druid. The Mushroom will lose potency after 1 year of real time.

**Note:** Copy enough of each Player Handout 1 to 3 so that each PC can receive one.

---

CUT

---

## PLAYER HANDOUT #1

Finally taking a much-needed holiday from adventuring, you decide to walk among the common folk of Dyvers for a change of pace. For the most part things are fairly humdrum. Occasionally you see a baker hawking his wares or the occasional city guard half asleep watching the citizens pass by his post. Being almost ready to ditch this idea and go looking for something a bit more interesting, you hear someone clear their throat off to the left. "I'm so sorry to impose but I thought you might be...yes you definitely match my friend's description... it has to be you...my I am so happy to meet you in person. I am honored! I hope you don't think this to be fresh, but I have been granted passage for two to Makilon for the monastery's exclusive showing of their book on Dyvers history. Having been a little bit irresponsible, I let time get away and now I don't have an escort to the event. I would be very honored if you would join me. Of course I understand that this has been an imposition, and you probably only have your adventuring togs handy and not your finer clothes. Fret not, I am on my way to the "Fine Threads Fast" tailoring shop, and they have amazing seamstresses on staff also. It would be my honor to pay for suitable clothing for you for the inconvenience. Please say you'll join me! I'd feel much more at ease knowing I was in your company, as the Nyr Dyv has had the occasional pirate sail it's waters in the past."

When you have decided if you'll accept or not write down your answer in the space below and hand it to the judge.

---

CUT

---

## PLAYER HANDOUT #2

You can obviously tell your new friend is pleased. "Thank you very much for accepting. I'm sure we'll have an excellent time!"

For a bit you travel the streets of the city and arrive at Fine Threads East shop. As your friend has an appointment, you are fitted in no time and told to come back in a few hours to pick up your new clothes. Not wanting to let the afternoon drag, your host treats you to a fantastic meal and wants to hear all about your daring adventures. Time flies, and before you know it the clothes are ready and it is time to embark on the trip to Makilon. As you arrive on the docks the ship you're to travel on, the "Top Line," is preparing to take on passengers.

---

CUT

---

## PLAYER HANDOUT #3

For a moment your friend looks a bit perplexed, almost as if his/her feelings have been hurt. Then quickly his/her eyes light up. "Forgive me! Of course I could not expect you to take a holiday while others go unattended. I am a bit philanthropic myself and would be proud to make a donation to your favorite charity if you could find the time to go with me." In short order, your friend reaches into a pouch and pulls out a small but nicely cut ruby and hands it to an attendant. "This is my trusted aid. Tell him what charity you would like the donation to go to and he will see to it that they have this shortly."

When you have decided if you'll accept or not write down your answer in the space below and hand it to the judge. You may not have the donation go to yourself or another player character.

PLAYER HANDOUT #4

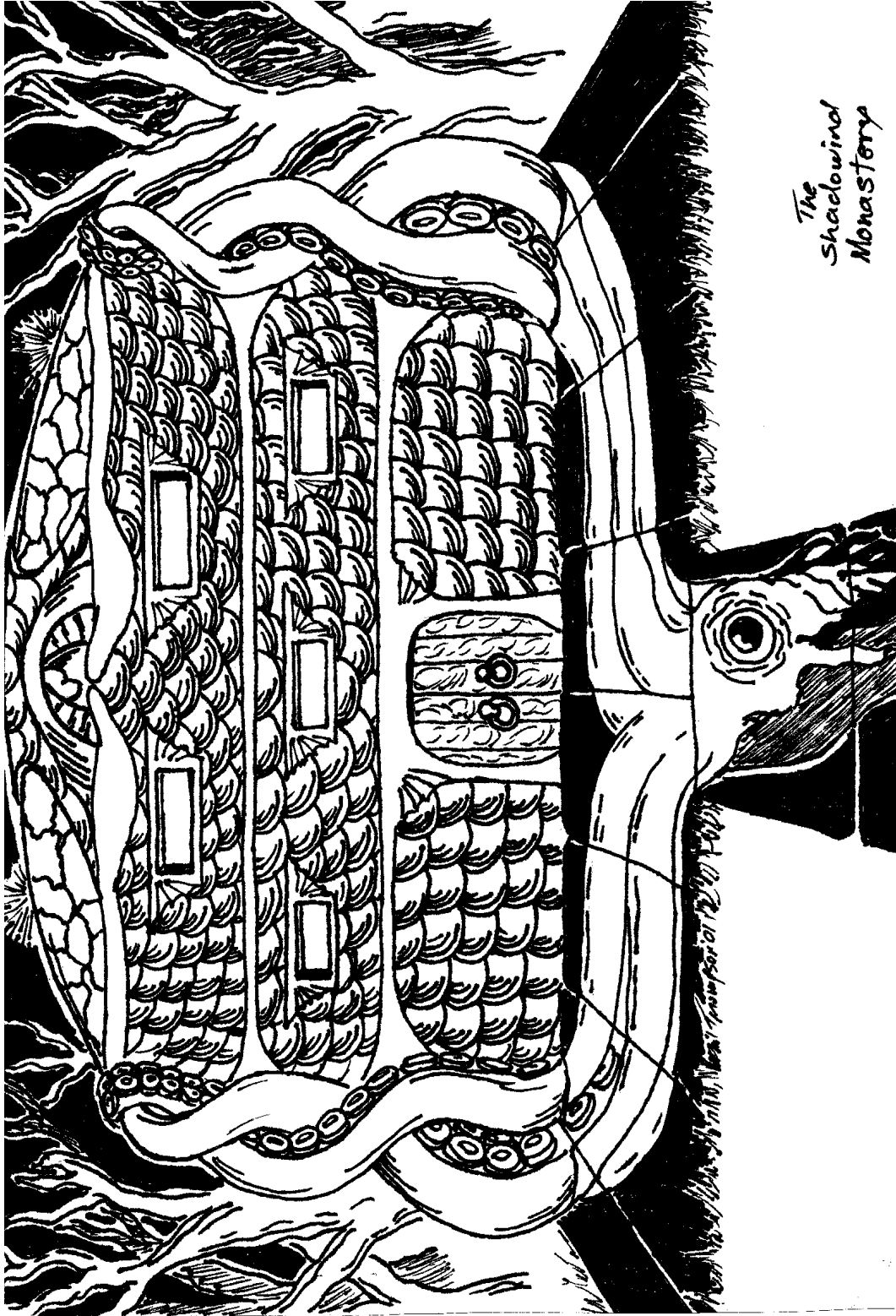

The  
Shadowwind  
Monastery





PLAYER HANDOUT #5

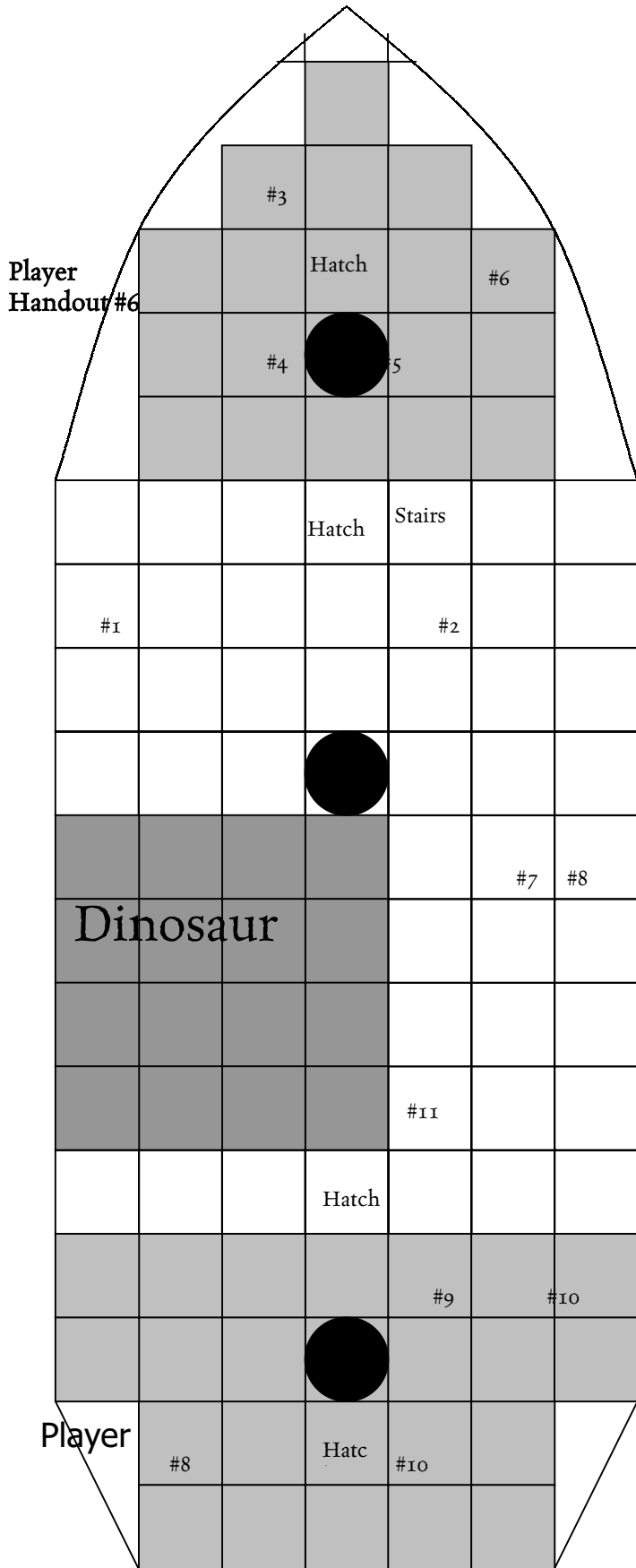



**"Top Line" Legend**

 10' higher than base deck

 Mast

#s 1-12 are the Captain and the Crew. There are 6 more below deck. The hatches and Stairs fill the squares they are labeled in.

# The "Top Line"

Scale for all ship maps  
1 square = 5 ft.

Base Deck

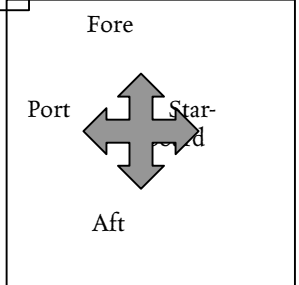

## HALSTON JEVIN'S JOURNAL

*While you've handled undesirable things this ranks up near the top. What was once a simple logbook has now become grimy over the course of the dig. Additionally, Halston's profuse sweating during his panic has made it almost illegible. However, some of it is recoverable.*

### 1 WEEK AGO

*We finally managed to finalize our agreement with Master T'Qan and the Shadowwind Order. Tomorrow we set out for the dig to set up camp. I can hardly contain myself as we near my goal. I regret my duplicity, but hopefully my colleagues will understand and will be as excited about what I hope to find as I am.*

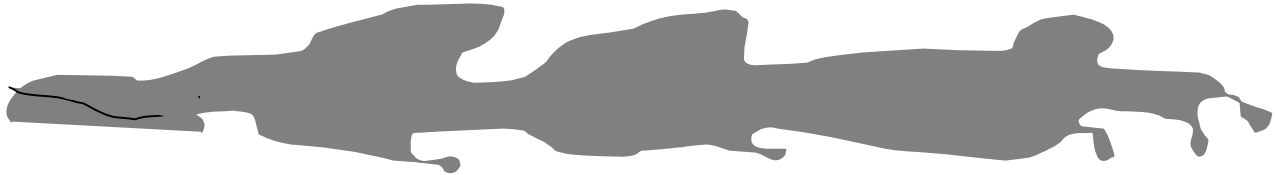

### 4 DAYS AGO

*Camp is set up and we've set about cataloging the entry room. As surmised there have been others here, and although we have found a few artifacts, it is nowhere near what my colleagues hoped to find. Soon I will go back to the monastery to hopefully bring back the adventurers I've recruited through my contacts in Dyvers. It was a shame to dupe them also, but the Shadowwind Order was very adamant about unneeded people in the dig.*

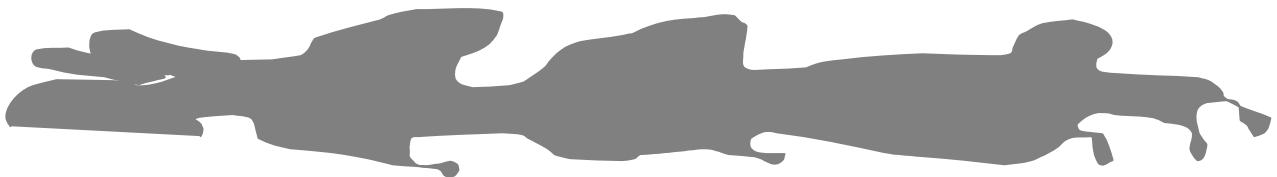

### YESTERDAY

*I am ecstatic. Tomorrow the adventurers will be here, and after enduring the ceremony I will finally be onward to my true goal. I've had to compromise some of my morals to achieve this, but it will set my friends and I up for life. Ah, the power of gold is strong indeed.*

DYV1-09

# THE POWER OF GOLD

A One-Round D&D LIVING GREYHAWK<sup>®</sup>  
Dyvers Regional Adventure

Version 1

## ROUND 2

by Phil Thompson

While sometimes the life of an adventurer can be a tough one every once in a while it pays off. Today has been fantastic! Your hard work has finally paid off and you've been invited to a prestigious event. Life couldn't get any better than this. Perhaps fate has finally smiled upon you. Part two of the Kadoran series. An adventure for characters level 1-8.

DUNGEONS & DRAGONS, D&D, GREYHAWK and RPGA are registered trademarks of Wizards of the Coast, Inc. LIVING GREYHAWK is a trademark of Wizards of the Coast, Inc. Scenario detail copyright 2001 by Wizards of the Coast, Inc. ALL RIGHTS RESERVED. This scenario is intended for tournament use only and may not be reproduced without approval of the RPGA Network.

This is an RPGA® Network scenario for the Dungeons & Dragons® game. A four-hour time block has been allocated for each round of this scenario, but the actual playing time will be closer to three hours. The rest of the time is spent in preparation before game play, and scoring after the game. The following guidelines are here to help you with both the preparation and voting segment of the game. Read this page carefully so that you know and can communicate to your players the special aspects of playing an RPGA scenario.

## PREPARATION

First you should print this scenario. This scenario was created to support double-sided printing, but printing it single sided will work as well. There is enough room along the inside margin to bind the adventure, if you desire.

Read this entire adventure at least once before you run your game. Be sure to familiarize yourself with any special rules, spells, or equipment presented in the adventure. It may help to highlight particularly important passages.

When you run an RPGA D&D adventure we assume that you have access to the following books: the *Player's Handbook*, the *Dungeon Master's Guide*, and the *Monster Manual*. We also assume that you have a set of dice (at least one d4, d6, d8, d10, d12, and d20), some scrap paper, a pencil, an RPGA scoring packet, and your sense of fun. It is also a good idea to have a way to track movement during combat. This can be as simple as a pad of graph paper and a pencil, as handy as a vinyl grid map and chits, or as elaborate as resin dungeon walls and miniatures.

Instruct the players either to prepare their characters now, or wait until you read the introduction, depending on the requirements of the scenario as described in the introduction.

Keep in mind that you must have at least four players (not counting the DM), for the game session to be a sanctioned RPGA event. As well, you cannot have more than seven players participating in the game.

Once you are ready to play, it is handy to instruct each player to place a nametag in front of him or her. The tag should have the player's name at the bottom, and the character's name, race, and gender at the top. This makes it easier for the players (and the DM) to keep track of who is playing which character.

The players are free to use the game rules to learn about equipment and weapons their characters are carrying. That said, you as the DM can bar the use of even core rule books during certain times of play. For example, the players are not free to consult the *Dungeon Master's Guide* when confronted with a trap or hazard, or the *Monster Manual* when confronted with a monster.

Some of the text in this scenario is written so that you may present it as written to the players, while other text is for your eyes only. Text for the players will be in gray boxes. It's strongly recommended that you paraphrase the player text instead of reading it aloud. Some of this text is general and must be adapted to the specific situation or to actions of the player characters.

## SCORING

After the players have completed the scenario or the time allotted to run the scenario has run out, the players and DM score the game. The RPGA has three ways to score its games. Consult your convention coordinator to determine which method to use for this scenario:

4. No-vote scoring: The players write their names and RPGA numbers on the scoring packet grid. You fill in the top of the grid. That is all. No one is rated. This method is used for people who are just playing for fun.
5. Partial scoring: The players rate the game master and the scenario on their player voting sheet, and provide personal information, but don't vote for other players. The game master rates the scenario and completes personal and event information, but does not rate the players as a team or vote for players. This method is used when there is no competition, but the event coordinator wants information on how the game masters are performing, or the game master wants feedback on his or her own performance.
6. Voting: Players and game masters complete the entire packet, including voting for best player. If this method is used, be sure to allow about 15-20 minutes for the players to briefly describe their characters to the other players, and about 5-10 minutes for voting. This method is used when the players want to know who played the "best" among the group, or when the adventure is run in tournament format with winners and prizes.

When using voting, rank the players in order of your voting choice while they are completing their forms, so that you are not influenced by their comments on your abilities. It's a good idea to have the players vote while you determine treasure and experience awards for the scenario.

After voting, give the Scoring Packet to your event coordinator.

This is a LIVING GREYHAWK Adventure. As a Living™ adventure, it is expected that players will bring their own characters with them. If players do not have a LIVING GREYHAWK character generated, get a copy of the current LIVING GREYHAWK character generation guidelines, a character sheet, and a LIVING GREYHAWK log sheet from your convention coordinator or the RPGA Web site, and then have any players without a character create one. Once all players have a LIVING GREYHAWK character, play can begin.

Along with the other materials that you are assumed to have in order to run a D&D game, it is also recommended that you have a copy of the LIVING GREYHAWK *Gazetteer*.

## DETERMINING AVERAGE PARTY LEVEL (APL)

Because players bring their own characters to LIVING GREYHAWK games, this adventure's challenges are proportioned to the average character level of the PCs participating in the adventure. To determine the Average Party Level (APL):

- 5) Determine the character level for each PC participating in the adventure.
  - 6) If PCs bring animals that have been trained for combat (most likely war horses, dogs trained for war), other than those brought by virtue of a class ability (i.e., animal companions, familiars, paladin's mounts, etc.) use the following chart to determine the number of levels you add to the sum above. Add each character's animals separately. A single PC may only bring four or fewer animals of this type, and animals with different CRs are added separately.
- | CR          | 1 | 2 | 3 | 4 |
|-------------|---|---|---|---|
| 1/4 and 1/6 | 0 | 0 | 0 | 1 |
| 1/3 and 1/2 | 0 | 0 | 1 | 1 |
| 1           | 1 | 1 | 2 | 3 |
| 2           | 2 | 3 | 4 | 5 |
| 3           | 3 | 4 | 5 | 6 |
| 4           | 4 | 5 | 6 | 7 |
- 7) Sum the results of 1 and 2, and divide by the number of characters playing in the adventure—round up.
  - 8) If you are running a table of six PCs, add one to that average.

By following these four steps, you will have determined the APL. Throughout this adventure, APLs categorize the level of challenge the PCs will face. APLs are given in even-numbered increments. If the APL of your group falls on an odd number, ask them before the adventure begins whether they would like to play a harder or easier adventure. Based on their choice, use either the higher or the lower adjacent APL.

APL also affects the amount of experience you may gain at the end of an adventure. If your character is three character levels or more either higher or lower than the

APL that this adventure is played at, that character will receive only half of the experience points awarded for the adventure. This simulates the fact that either your character was not as challenged as normal, or relied on help by higher-level characters to reach the objectives.

**Note:** LIVING GREYHAWK adventures are designed for APL 2 and higher. Three or four, or sometimes even five 1<sup>st</sup>-level characters may find difficulty with the challenges in a LIVING GREYHAWK adventure. If your group is APL 1 there are three things that you can do to help even the score.

- 4) Attempt to create a table of six 1<sup>st</sup>-level characters, or try to enlist higher-level characters to play at that table.
- 5) Advise characters to buy riding dogs to help protect them, and fight for them. All riding dogs are considered trained to attack. PCs who want their dog to attack they must succeed at a Handle Animal or Charisma check (DC 10). Failure indicates that the animal will not attack that round. This is a free action (spoken command) that may be attempted each round. If an animal loses half or more hp in a single round it flees, unless another check is successful.
- 6) A group of APL 1 adventurers who desire an extra hand can "enlist an iconic." The stats for the 1<sup>st</sup>-level versions of Tordek, Mialee, Lidda and Jozan are given at the end of each adventure. The group may pick one of these characters to joint them on this adventure. The DM controls that NPC.

If you are using a 591 CY adventure (campaign year 1) that uses the old Tiers, assume that the Tier multiplied by 2 is the APL suitable for that encounter.

## IS IT A FULL MOON?

Since the hazards of lycanthropy are a current part of the LIVING GREYHAWK campaign, it may be necessary to determine if this adventure takes place during a full moon. For game purposes, the full moon lasts three days of each month. For a given scenario that does not state the phase of the moon, roll 1d10 before play begins. On a result of 1, the first day of the scenario is a night of the full moon (roll 1d3 to determine where in the sequence of three nights it falls).

## LIFESTYLE

At the beginning of every scenario, each PC is required to pay upkeep costs matching the level of lifestyle they wish to maintain. The lifestyles, and the effects that each has on play, are:

**Destitute:** You have no living space, and must carry all your gear everywhere. You eat poor quality food. You wear a peasant outfit, your only change of clothes.

**Poor:** You sleep in poor accommodations, and eat poor quality food. You wear a peasant outfit, and have two sets of clothing.

**Common:** You have common lodgings, and eat common quality food. You have normal clothing for your profession (adventuring); nothing fancy. You probably have two or three sets of clothing.

**High:** You stay in good quality lodgings, and eat good quality food. You wear anything in value up to courtier's outfits, and generally buy a new set of clothing every two weeks.

**Luxury:** You have luxurious accommodations (twice the cost of good accommodations), and you eat excellent foods. You can throw a banquet for your friends every day, and frequently do. You wear clothing up to the value of noble's outfit, and buy a new set of clothes every week.

Lifestyles come with bonuses or penalties to Diplomacy, Intimidate, Disguise, and Bluff skill checks. These penalties, shown below, should be applied at the DM's discretion, and can sometimes backfire—for example, a PC with a poor lifestyle would not have a penalty when talking to a beggar, but would when talking to a city official. A PC with a high lifestyle should have a penalty when dealing with a group of street thugs, where a PC with a destitute lifestyle might not.

DMs are encouraged to role-play these reactions whenever possible.

Lifestyle Cost	Skill Modifier	
Destitute	14 sp	-2
Poor	43 sp	-1
Common	12 gp	0
High	250 gp	+1
Luxury	500 gp	+2

## ADVENTURE SYNOPSIS

This adventure ideally will have both rounds back to back with the same group. Unfortunately, life and other things can keep this from happening. Thus, it may be necessary to bring new players into the round. This can be done in one of several ways.

- 1) The PC was a late arrival to the island.
- 2) The PC was at the viewing in round one, but became ill due to the different cuisine, but felt better later and decided to catch up with the group at the dig.
- 3) The original party decided to go back to the monastery at the end of round one. Due to obligations, injury, or other reasons, one or more of the original party could not return to the dig and a PC from a later ship took their place.

This round starts in front of the dig with the PCs having the chance to explore it to find the missing archaeologists. They also may return to the monastery if they wish before entering (The aftermath of Round 1 is recapped in this round in case this happens.). If the PCs make it through the dig, they find a tunnel that runs to another island where they encounter shipwrecked slavers and a captive.

## PLAYER INTRODUCTION

The PCs will arrive at Round 2 by surviving Round 1. If players start out in Round 2 without playing Round 1 it will be because of one of the reasons given in the adventure synopsis listed above.

About the dig:

Unless otherwise noted, all the rooms and passages in the dig are 14 feet tall and made out of light green stone. The doors are 9 feet tall and 4 feet wide. The doors are not locked, but have grown swollen and stuck over time. The DC to break them open is 13. The doors will open automatically for the Zombies unless spiked, blocked, or magically held. The Secret Doors can be found with a successful Search check of 15.

Note about the protector(s) of the Dig:

The dig on Makilon is haunted by a malevolent spirit who was disturbed by the archaeologists going into Room 2 (On DM's map 1). Currently the spirit is sated, and it's protector(s) reside in Room 13 (on DM's #1). Should the PCs go into Room 2, the protector(s) will rise to find them. Over time, the spirit's power has waned to the point that it can no longer pinpoint where the PCs are, but can vaguely sense if the intruders have entered and spur the protectors on to look for intruders. The protectors will search the dig room by room until the intruders leave or are found. They will conduct the search in the following manner. Three real time minutes after the PCs go into Room 3, the protectors will search Room 12. From there, (4 real time minutes later) they will go to Room 11. For every 4 minutes of real time after that they will search the rooms in the following order 10, 9, 8, 7, 6, 4, 3, 5, 2, 1, 2, 3, 4, 6, 7, 15, 14, 7, 8, 9 and then repeat the search pattern. The protectors will not willingly leave the dig nor go down the stairs in Room 14. If faced with being turned to an area that is off limits to them they will dissolve into a cloud of vapor and return to Room 13. In Room 13 they can be turned and also destroyed by clerical turning. They cannot be controlled by anything other than the spirit that is guiding them. The undead have Turn Resistance (DUNGEON MASTER's Guide page 83, They are treated as 2hd higher for turning purposes due to the Turn Resistance.).

If the protectors are defeated by any means other than total destruction by acid, disintegration, clerical turning, or defeating them in Room 13 (This is where they were created and thus defeat here will destroy them permanently. They do not know this, however and the spirit spurring them on can no longer make them leave

combat) they will dissipate. Four real-time minutes after they dissipate they will arrive in Room 13. On the following round they will reform and start their search again (using the same room pattern). If the PCs reach Room 13 and the protectors are elsewhere or defeated elsewhere the protectors will reform on the following round outside the door to Room 13.

Unless the doors are spiked shut or magically held shut, they will open for the protectors. Spiked or magically held doors will keep them out for 1 round.

## ENCOUNTER 1: THE START OF THE DIG (ROOM 1)

*As you enter from the cave above, you notice that there are broken digging tools, cots, and crates all over the room. The walls are splattered with blood and bits of hair and skin. In stark contrast to the carnage, each wall bears a continuous fresco of water creatures (frogs, fish snakes and turtles living in harmony with each other). There is a door in the west wall.*

## ENCOUNTER 2: INTRUDER ALARM (ROOM 2)

The hallway to this room slopes downward 20 feet (The PCs are now 35 feet under ground.). If the PCs succeed a stonemasonry or Knowledge (engineering) (or like skill) DC 11, they will notice that they are traveling downward. By making a successful check DC 19, they can determine the depth.

The room is made of slate gray stone and if illuminated will be slightly darker than normal as if some residual magic still lingered in here. The floor is scattered with parchment papers and broken inkbottles. If looked at, it tells of the archaeologist's exploration of the dig thus far. Give the PCs Player Handout #2 if they search the room.

If the PCs go in here it will awaken the protectors in Room 13. (This will also happen if the PCs leave and come back via Room 14.)

## ENCOUNTER 3: A VIEW FROM THE INSIDE (ROOM 3)

The hallway to this room slopes downward 10 feet (The PCs are now 45 feet under ground). If the PCs make a stonemasonry (or like skill) DC 13 they will notice that they are traveling downward. With a successful Stonemasonry check (or like skill) DC 19 they can determine the depth.

*The walls and ceiling are all covered in fresco. The ceiling's center is done in light blue that gradually turns into a medium blue where it touches the wall. The tops of the walls are medium blue at the top and gradually change to a murkier blue with wispy green streaks at the part where they touch the floor. The*

*floor has a sandy brown color and bits of linen colored material can be seen.*

Closer inspection reveals this to be small bones. A nature, wilderness lore of like DC check of 15 will reveal that these are made to look like fish bones.

## ENCOUNTER 4: THE SERPENT'S COILS (ROOM 4)

The hallway to this room slopes downward 5 feet (The PCs are now 50 feet under ground.). If the PCs succeed at a Stonemasonry (or like skill) DC 15, they will notice that they are traveling downward. With a successful Stonemasonry check (or like skill) DC 19, they can determine the depth.

*Three feet from the floor, there is a 3-foot high mosaic that runs across all four walls and the doors. It is fashioned to look like a water snake with the head being on the north door. The snake design flows over the other door in the room. This is obviously the work of a master craftsman. It is apparent that if the door is closed the snake's head will touch the tail.*

If both doors are closed without the word "Girask" being spoken, and someone is inside the room, the walls and door will shimmer (Unless held open the doors will close. They were constructed to do this) and giant snakes will materialize and come out of the wall. If the snake is defeated, it will crumble to dust.

### APL 2 (EL 3)

☠ Snake, Huge Viper (1): hp 22; see *Monster Manual* page 202.

### APL 4 (EL 5)

☠ Snake, Huge Viper (3): hp 22; see *Monster Manual* page 202.

### APL 6 (EL 7)

☠ Snake, Huge Viper (6): hp 22; see *Monster Manual* page 202.

### APL 8 (EL 9)

☠ Snake, Huge Viper (12): hp 22; see *Monster Manual* page 202.

## ENCOUNTER 5: WASTED AWAY (ROOM 5)

The hallway to this room slopes downward 20 feet (The PCs are now 65 feet under ground.). If the PCs make a



stonecunning (or like skill) DC 14 they will notice this. The floor is carved to look like the underside of a turtle's shell. Unlike what you've seen so far this room is dimly lit by a small dimly glowing floating sphere of light about 1 foot in diameter. When the PCs open the door, it will brighten to half daylight and slowly bob over toward them, but will stop when it gets within 2 foot of any PC. If the Protector(s) are here they will ignore each other. Sprawled out upon the floor is a skeleton of an oddly boned humanoid (Roughly 6 ½ feet tall with a 5-foot tail. It is a lizardfolk.) that has been chained to the floor (The chain is set in the floor 10 feet from the north wall and 3 feet from the east. The chains are 6 feet long and rusted almost to the point of being brittle.). The humanoid is almost in a prostrate praying position.

## ENCOUNTER 6: THE SPIRIT'S CHAMBER (ROOM 6)

The hallway to this room slopes downward 15 feet (The PCs are now 65 feet under ground.). If the PCs make a stonecunning (or like skill) DC 11 they will notice that they are traveling downward. With a successful Stonecunning check (or like skill) DC19, they can determine the depth. The door to this room has been sealed with a wax-like residue. PCs wishing to make a Spellcraft check DC 24 will notice that material like this might be used in binding an outsider. The substance is pitted and mottled as if heat had at one time been applied to it. It does not impede the opening of the door. The walls, floor, and ceiling are smooth, seamless river stone in the center of the floor is a circular engraving. There are the skeletons of three humanoids in the center of it. A successful Spot check DC 19 will reveal that part of the engraving has been damaged.

This is where the sacrifices were made long ago to trap the spirit to the dig. Over time the magics have faded and allowed the spirit to lose power. Now it is an ambiguous force instead of a direct one.

**Note:** Even if the engraving is fixed or somehow erased the spirit's power will remain unchanged.

## ENCOUNTER 7: DISPOSAL UNIT (ROOM 7)

The hallway to this room slopes downward 5 feet (The PCs are now 70 feet under ground.). If the PC s make a Stonecunning (or like skill) DC 11 they will notice that they are traveling downward. With a successful Stonecunning check (or like skill) DC19 They can determine the depth.

This room is inlaid with broken mussel shells and center of the floor is 1 ft lower than the rest of the floor (It tapers gradually from the edge to the center.). The floor also has a large gaping maw crafted into its center. Near the center of the maw is a human femur sticking 6

inches out of the ground. It is brittle and may be broken off easily. If explored, it appears the rest of the bone is fused into the stone floor. When the magic in the complex was stronger, this was a disposal area. Things of up to 1 feet by 1 feet by 1 feet in area would be transported to the Nyr Dyv.

## ENCOUNTER 8: TOXIN STORAGE (ROOM 8)

The hallway to this room slopes downward 10 feet (The PCs are now 80 feet underground.). If the PCs make a Stonecunning (or like skill) DC 11, they will notice that they are traveling downward. With a successful Stonecunning check (or like skill) DC19, they can determine the depth.

The walls and floor of this room are slate gray. There are 4 urns along the east wall (Labeled A-D. 1 foot from the east wall and spaced evenly apart.). The urns are made from unfired glazed clay. Any PC making a Spot check DC 21 will notice that urn "B" has a small dark stain at its base. All the urns are sealed.

**Urn "A"** is filled with skeletons of small water creatures. These were test subject to be carriers of the toxins. The amount given to each was small, and by themselves they are non-toxic. If more than 3 skeletons are taken by any PCs and handled carelessly, (by bare skin contact or if gloves, gauntlets etc.) they will need to make a fortitude save DC 12 or lose 1d4 constitution points for 1 hour.

**Urn "B"** is empty save for lighter than air poisonous gas. The gas was at one time suspended in a gel-like fluid, but over time the fluid leaked out through a stress crack leaving the gas trapped in the upper cavity of the urn's sealed top. If opened, the urn will release the gas. All in a 5-foot radius must make a Fortitude save DC 14 or lose 1d6 Constitution points for 2 hours.

**Urn "C"** is filled with dried lake plants. (These were used in the production of the toxin but are non-toxic by themselves.)

**Urn "D"** is filled with river stones ranging from 1 inch to 3 inches in diameter. The stones we used in the creation of the gas in urn "B." If handled carelessly (by bare skin contact or if gloves, gauntlets etc.) they will need to make a Fortitude save DC 12 or lose 1d4 Constitution points for 1 hour.

## ENCOUNTER 9 (ROOM 9)

The hallway to this room slopes downward 10 feet (The PCs are now 90 feet underground.). If the PCs make a Stonecunning (or like skill) DC 10 they will notice that they are traveling downward. With a successful Stonecunning check (or like skill) DC19, they can determine the depth.

## ENCOUNTER 10: THE DOORMAN (ROOM 10)

The hallway to this room slopes downward 20 feet. The PCs are now 110 feet under ground.) If the PCs make a Stonecunning (or like skill) DC 11 they will notice that they are traveling downward. With a successful Stonecunning check (or like skill) DC 19, they can determine the depth.

**There is a door in the south wall and an old pool or fountain sits in the center of the room.** (The pool is 8 feet in diameter. The sides of the pool are 1 foot tall and the pool is 2 feet deep. It is filled with old plants.) In the center of the fountain is a 17' statue of humanoid resting on a wave. Closer inspection reveals that the humanoid's skin is carved to look like it is scaled and its eyes appear to be fishlike.

✦ **Falling Statue Trap:** If a Will save DC 14 is made, then affected PCs need to make a Reflex save DC 17 to avoid. If they fail the will save then they need a reflex save DC 18 to avoid.

If the PCs inspect the statue for compartments, secret doors, or other such things they run the risk of setting off a trap (DC 24). If the trap is not found, the statue will lower ½ inch into the ground and will emit (from the mouth) a screeching, growling sound. (Tell the PCs it moved. They may make a spot check DC 22 that it moved into the ground. This movement happens very quickly.) Have the PCs make a will save DC 14 and then a reflex save DC 17 if they are in the room and standing in front or to the side of the statue. (If they failed the will save then they need a DC 18 for the reflex save.)

Those who are behind the statue or out of the room when it falls take no damage from it.

Those who are in front of the statue and fail the Reflex save take 1d6 +3 points per tier damage as it breaks apart and falls.

Those who are on the sides of the statue and fail the Reflex save take 1d4 + 2 points per tier damage as it breaks apart and falls.

If the PCs make a spot check DC 19, they will notice a faint odor in the air. (When the statue was touched it was released to sink slightly in the floor pushing heavier than air gas up into vents inside it causing the screeching, growling sound. This gas quickly ate away at the specially prepared mortar that held the various pieces of it together. When this happened it tipped slightly forward and fell apart.)

## ENCOUNTER 11: THE STAFF OF KADORAN'S LAST RESTING PLACE (ROOM 11)

The hallway to this room slopes downward 20 feet (The PCs are now 130 feet under ground.). If the PCs make a Stonecunning (or like skill) DC 10 they will notice that they are traveling downward. With a successful Stonecunning check (or like skill) DC 19, they can determine the depth.

**This appears to have been a chapel at one time. However, the benches and altar have been overturned and broken, as if some great struggle took place here long ago.**

If the PCs search through the room's debris (DC 15 for a normal search, DC 13 if they state that they are taking extra effort to look.) they will find the remnants of a skeletal arm that is clutching a strange looking mahogany staff. This is the Staff of Kadoran, the staff for which Halston Jevin has been searching.

It was here that some 200 years ago the thieves that slew Kadoran and stole his staff met their demise at the hands of the dig's protectors. The wielder of the staff was thrown across a jagged part of the altar and lost his arm. It was left as the protectors had most of the body to carry back with them and the spirit was appeased. The staff is missing pieces due to the thieves selling the parts of it that were removable to live off of. Where the missing pieces are now or even if they still exist is unknown.

## ENCOUNTER 12 (ROOM 12)

The hallway to this room slopes downward 10 feet (The PCs are now 140 feet under ground.). If the PCs make a Stonecunning (or like skill) DC 10 they will notice that they are traveling downward. With a successful Stonecunning check (or like skill) DC 19, they can determine the depth.

## ENCOUNTER 13: THE PROTECTORS (ROOM 13)

The hallway to this room slopes downward 30 feet (The PCs are now 170 feet under ground.). If the PCs make a Stonecunning (or like skill) DC 10 they will notice that they are traveling downward. With a successful Stonecunning check (or like skill) DC19, they can determine the depth.

This is where the protector(s) dwell. Unless the PCs have already permanently defeated the guardian(s) (See note before Encounter #1), they will find them here. The bodies of the missing archaeologists and several unidentifiable skeletons are also here. They have been thrown in the southwest corner of the room. The room and walls are of rose granite and are tinted with the blood of the missing archaeologists and other victims

The undead will attack.

**Suddenly, the door in slams open and the foul stench of the grave permeates the room. A shadowy figure that appears to be freshly deceased shambles toward you. Her drooping, baleful eyes look at**

you as she speaks with hatred of your living state. "You have come to your doom. None of you will leave here alive!"

The zombie will not follow the PCs if they leave the excavation.

### APL 2 (EL 3)

➤ **Huge Zombie** (1): hp 55; see *Monster Manual* page 192.

### APL 4 (EL 5)

➤ **Huge Zombies** (3): hp 55; see *Monster Manual* page 192.

### APL 6 (EL 7)

➤ **Huge Zombies, advanced, 11 HD** (3): CR 4; Huge undead; HD 11d12+3; hp 70 each; Init -1; Spd 40 ft.; AC 11 (touch 7, flat-footed 11); Atk +8 melee (2d6+7, slam); SQ Undead, partial actions only; Face/Reach 10 ft. by 10 ft./15 ft.; SV Fort +2; Ref +1; Will +6; Str 21, Dex 8, Con-, Int-, Wis 10, Cha 1.

*Feats:* Toughness.

**Partial Actions Only (Ex):** Zombies have poor reflexes and can perform only partial actions. Thus they can move or attack, but can only do both if they charge (a partial charge).

### APL 8 (EL 9)

➤ **Huge Zombies, advanced, 11 HD** (6): see above.

## ENCOUNTER 14 (ROOM 14)

The hallway to this room slopes downward 60 feet (The PCs are now 130 feet under ground.). If the PCs make a stonecunning (or like skill) DC 10 they will notice that they are traveling downward. With a successful Stonecunning check (or like skill) DC 19, they can determine the depth.

In the center of the room is a flight of stairs going down. They go another 200 feet (The PCs are now 330 feet under ground.) before they level off into a tunnel of semi-tooled stone. If the PCs make a Stonecunning (or like skill) DC 10 they will notice that they are traveling downward. With a successful Stonecunning check (or like skill) DC 21, they can determine how deep they are. The tunnel goes north for about a mile before it begins to rise. From here the tunnel gives way to tooled stairs and they rise 350 feet upward to another island. The top of the stairs is blocked by a minor cave-in. It will take 2 hours for 1 PC to clear a man-sized hole. Additional PCs can reduce this time by ½ to a minimum of ½ hour of clearing time.

**Note:** If the protectors have not been destroyed then they will roam the dig as before if the PCs come back.

## ENCOUNTER 15: FADED GLORY (ROOM 15)

This room is almost totally devoid of distinguishing features, save for a large damp area near the top of the south wall. The rest of the walls and floor are slightly damp. If a tracking DC 22 check is made then track(s) (1 set in tier 1 and 3 in tiers 2-4) are noticeable going to the door leading to the hallway the PCs came in from

## ENCOUNTER 16: A STRANGE NEW CAVE

Once the stairway has been cleared the PC will find that they empty into a small cave on an island roughly 9/10's of a mile from Makilon. Unfortunately, the fog that was seen earlier is now thicker, and Makilon cannot be seen from this island. In the distance you hear the sounds of suffering.

If the PCs wish to investigate go to Encounter 17

## ENCOUNTER 17: AN ENCOUNTER WITH SLAVERS

If the PCs approach the slavers, use an opposed Move Silently check. The slaver or PC that wins the opposed check will be able to act (There may be more than one if they tie. Some of the slavers get bonuses to this roll. It is detailed with their stat block in the tier.). All others are flat-footed. Once those that win the opposed Move Silently check have gone, then roll initiative as normal. When this check is over the PCs will see at least 5 humans in a clearing (See DM's Map #2). One of the humans is bound and is being tormented by another one. The others do not appear to want to interfere.

The slavers were washed ashore here with their captive from the sunken vessel "Harbringer." It sank 1 week ago in a storm north of Dyvers. The slavers do not know of the passage in the cave and assume the PCs have a ship. They will attack to take it. The slavers have 2 days of rations left.

### APL 2 (EL 4)

➤ **The Slavers, Barls, Timlock, Satal and Olack, male humans Ftr1** (4): CR 4; Medium-size humanoid (human); HD 1d10; hp 10; Init +0, Spd 30 ft.; AC 14 (touch 12, flat-footed 12); Atk +3 melee (1d8+2/19-20, longsword); AL NE, SV Fort+2, Ref +0, Will +1; Str 14, Dex 11, Con 11, Int 10, Wis 12, Char 10.

*Skills and Feats:* Climb +5, Profession (Sailor) +4, Swim +5, Use Rope +5; Dodge, Mobility

*Possessions:* Leather armor, longsword, dagger.

### APL 4 (EL 6)

➤ **The Slavers, Barls, Timlock, Satal and Olack, male humans Ftr3** (4): Medium-size humanoid (human); HD 3d10; hp 20; Init +0, Speed 30 ft.; AC 14 (touch 12, flat-footed 12); Atk +5 melee (1d8+2/19-20, longsword); AL NE; SV Fort +3, Ref +1, Will +2; Str 14, Dex 15, Con 11, Int 10, Wis 12, Cha 10.

*Skills and Feats:* Climb +7, Profession (sailor) +6, Swim +7, Use Rope +7; Dodge, Mobility, Power Attack  
*Possessions:* Leather Armor, Longsword, Dagger.

➤ **Torzjak, male human Sor4:** Medium-size humanoid, (human); HD 4d4; hp 17; Init +4; Spd 30 ft., AC 12 (touch 12, flat-footed 12); Atk +0 melee (1d6, quarterstaff); AL LE; SV Fort+2, Ref +1, Will +5; Str 11, Dex 11, Con 12, Int 10, Wis 12, Cha 16.

*Skills and Feats:* Concentration +6, Gather Information +8, Knowledge (arcane) +5, Knowledge (local-Dyvers); History +5, Search +4, Spellcraft +4; Spell Focus (enchantment), Lightning Reflexes.

*Spells Known* (6/7/4; base DC = 13 + spell level): *ray of frost, daze, light, ghost sound, disrupt undead, read magic*; 1<sup>st</sup>—*burning hands, identify, magic missile*; 2<sup>nd</sup>—*invisibility*.

*Possessions:* Leather armor, dagger, quarterstaff

Torzjak is 10 feet back to the east of the slavers in the light woods. He was hired by the slavers and is loyal to them.

## APL 6 (EL 8)

➤ **The Slavers, Barls, Timlock, Satal and Olack, male humans Ftr6** (4): CR 6; Medium-size humanoid; HD 6d10; hp 46; Init +0; Spd 30 ft.; AC 14 (touch); Atk +8/+3 melee (1d8+2/19-20, longsword); AL NE, SV Fort+6, Ref +2, Will +3; Str 14, Dex 15, Con 12, Int 10, Wis 12, Char 10.

*Skills and Feats:* Climb +10, Profession (Sailor) +9, Swim +10, Use Rope +10; Dodge, Mobility, Power Attack, Cleave

*Possessions:* Leather armor, longsword, dagger.

➤ **Torzjak, human male Sor5** (1): CR 5; Medium-size humanoid (human); HD 6d4; hp 25; Init +4 (Improved Initiative); Spd 30 ft., AC 12 (touch 12, flat-footed 10), Atk +2 melee (1d6, quarterstaff); AL LE, SV Fort+2, Ref +1, Will +5; Str 11 Dex 11 Con 12 Int 10 Wis 12 Cha 16

*Skills and Feats:* Concentration +7, Gather Information +9, Knowledge Arcana +6, Knowledge (local-Dyvers) +6, Search +6, Spellcraft +6; Spell Focus (enchantment), Lightning Reflexes, Improved Initiative.

*Spells Known* (0/7/5; base DC = 13 + spell level): 0—*ray of frost, daze, light, ghost sound, disrupt undead, read magic*; 1<sup>st</sup>—*burning hands, identify, magic missile, charm person*; 2<sup>nd</sup>—*invisibility, knock*.

*Possessions:* Leather armor, dagger, quarterstaff.

Torzjak is 10 feet back to the east of the slavers in the light woods. He was hired by the slavers and is loyal to them.

## APL 8 (EL 10)

➤ **The Slavers, Barls, Timlock, Satal and Olack, male humans Ftr7** (4): Medium-size humanoid (humanoid); HD 7d10; hp 60; Init +1 (+1 Dex); Spd 30 ft.; AC 14 (touch 12, flat-footed 12), Atk +9/+4 melee (1d8+2/19-20, longsword); AL NE; SV Fort+7, Ref +3, Will +2; Str 14, Dex 15, Con 12, Int 10, Wis 12, Cha 10.

*Skills and Feats:* Climb +12, Profession (Sailor) +11, Swim +12, Use Rope +12; Dodge, Mobility, Power Attack, Cleave, Great Cleave

*Possessions:* Leather armor, longsword, dagger.

➤ **Torzjak, male human Sor8** (1) Medium-size humanoid (human); HD 8d4; hp 41; Init +5; Spd 30 ft.; AC 13 (touch 13, flat-footed 10); Atk +4 melee (1d6, quarterstaff); AL LE; SV Fort+3, Ref +3, Will +7; Str 11, Dex 16, Con 12, Int 10, Wis 12, Cha 16.

*Skills and Feats:* Concentration +8, Gather Information +8, Knowledge (arcane) +7, Knowledge (local—Dyvers) +7, Search +7, Spellcraft +7; Spell Focus (enchantment), Lightning Reflexes, Improved Initiative.

*Spells Known* (6/7/6/3; base DC = 13 + spell level): 0—*ray of frost, daze, light, ghost sound, disrupt undead, read magic, detect magic*; 1<sup>st</sup>—*burning hands, identify, magic missile, charm person*; 2<sup>nd</sup>—*invisibility, knock, web*; 3<sup>rd</sup>—*lightning bolt, stinking cloud*; 4<sup>th</sup>—*cone of cold*.

*Possessions:* Leather armor, quarterstaff, dagger.

Torzjak is 10 feet back to the east of the slavers in the light woods. He was hired by the slavers and is loyal to them and to Laurin.

## THE VICTIM

➤ **Erish, human male Ftr3** (1): Medium-size humanoid, (human); HD 3d10; hp 22; Init +0; Spd 30 ft.; AC 12 (touch 12, flat-footed 10); Atk +5 melee +5 (1d3+2 subdual, fist); AL LN, SV Fort+3, Ref +3, Will +1; Str 14 Dex 14 Con 10 Int 10 Wis 14 Cha 10.

*Skills and Feats:* Diplomacy +4, Handle Animal +4, Gather Information +2, Search +2; Cleave, Combat Reflexes, Iron Will, Improved Unarmed Strike, Power Attack.

*Possessions:* None except for the modest clothes on his back

## CONCLUSION

Erish will be very grateful if he is rescued. If he is brought back to the monastery, Master T'Quan will offer him a place to live. Master T'Quan will be very interested in both the passage to the other island and the slaver activity. Any surviving slavers that the PCs leave on

Makilon will be turned over to the next ship to Dyvers. The Dyvers Government will also be interested in slaver activity in Dyvers-controlled waters. Lawful neutral monks who participate in this round and complete it will receive the recommendation of Master T'Quan (See master T'Quan's Recommendation cert). Other PCs who complete the round will receive his thanks and are welcome back to Makilon Island in the future (See Makilon Island Visit cert).

### The End

## EXPERIENCE POINT SUMMARY

To award experience for this adventure, add up the values for the objectives accomplished. Then assign the discretionary roleplaying experience award. The roleplaying award should be given for consistent character portrayal and contribution to the fun of the game. You can award different roleplaying amounts to different characters.

Award the total value (objectives plus roleplaying) to each character.

#### Encounter 2

The PCs find the Archaeologist's notes 20 xp

#### Encounter 4

The PCs do not activate the snake 75 xp

Or

The PCs defeat the snake 50 xp

#### Encounter 8

The PCs handle the toxic substances without being poisoned 15 xp

#### Encounter 10

The PCs Destroy the protectors 140 xp

#### Encounter 11

The PCs do not set off the Statue Trap 20xp

#### Encounter 17

The PCs defeat the Slavers 145 xp

The PCs set Erish free and Erish lives 50xp

#### Aftermath

Reporting the tunnel to the monastery 35xp

**Total possible experience 500 xp**

## TREASURE SUMMARY

Player characters may keep items from the scenario that are listed on the treasure list below or which meet the following conditions:

- The item must be non-magical and specifically listed in the text of the adventure (e.g armor on foes). If it is not listed in the text, the characters cannot keep it. Items of this nature can be sold for 50% of book value, or recorded on a log sheet.
- Animals, followers, monsters, henchmen, and so forth (any living being, basically) may not be kept from a scenario for any reason unless the treasure summary lists the being specifically. It is okay for the player characters to form relationships with NPCs, but these will not be certified and cannot bring material benefit to the character. Contacts (sources of extra information) must be specifically certified.
- Theft is against the law, but may be practiced by some player characters. Items which are worth more than 250 gp that are of personal significance to the owner (including family heirlooms), and all magical items, will be discovered in the possession of the character by one means or another. The character must return the item and pay a fine equal to three times the value of the item stolen. In addition, the PC caught receives campaign-decided penalties for being known as a thief. For other stolen items which meet the criteria in #1 above, use your judgment and the circumstances within the game to determine whether a PC thief gets away with the theft or not.

Any item retained according to these rules, which does not have a certificate, will not ever have a certificate issued for it.

The campaign staff reserves the right to take away any item or gold acquired for things that it later finds unreasonable but which were allowed at the time.

#### Encounter 14

The Staff of Kadoran is the sole piece of treasure from this round.

- Staff of Kadoran:** (520 gp; 4 lbs) It is made of mahogany and is covered with odd ridges, slots, and tooled areas. It looks as if pieces are missing from it. Legend has it that Kadoran was a powerful sorcerer who created the legendary staff. Over time, however, his powers waned and thieves slew him in his sleep and took the staff. Also over the years, pieces from it were sold to cover their new lifestyle. Legend has it that these pieces still exist and may still hold magical power. The staff is a masterwork weapon. Once a day the, when the word "Dorkaan" is spoken the tip of the staff comes alight, as if a continual flame were cast upon it. This strange flame can be extinguished only by dousing it in running water. The staff also bestows a +2 insight bonus to

Spellcraft and Scry checks to the carrier of the staff, but the carrier only gains this bonus if he or she has at least one rank in both skills.

At the end of the adventure give the following certs to the PCs they apply to.

- **Master T'Quan's Recommendation:** This cert is awarded to a lawful neutral character with at least one level of monk who completed the adventure "The Power of Gold. That character receives the recommendation of Master T'Quan to join the Shadowind monastery
- **Makilon Island Visit:** This cert is awarded to characters who are with no levels of monk, or those who do but are lawful good. It grants them room and board at the Shadowind monastery, which allows them to live at a normal lifestyle at no cost during any one Dyvers Regional adventure in the future.

# DM's Map #1

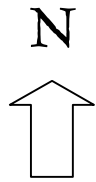

**LEGEND**

- Door (Arrow is direction it opens)
- Secret Door (Opens both directions)

Scale: 1 Square = 5 x 5 feet

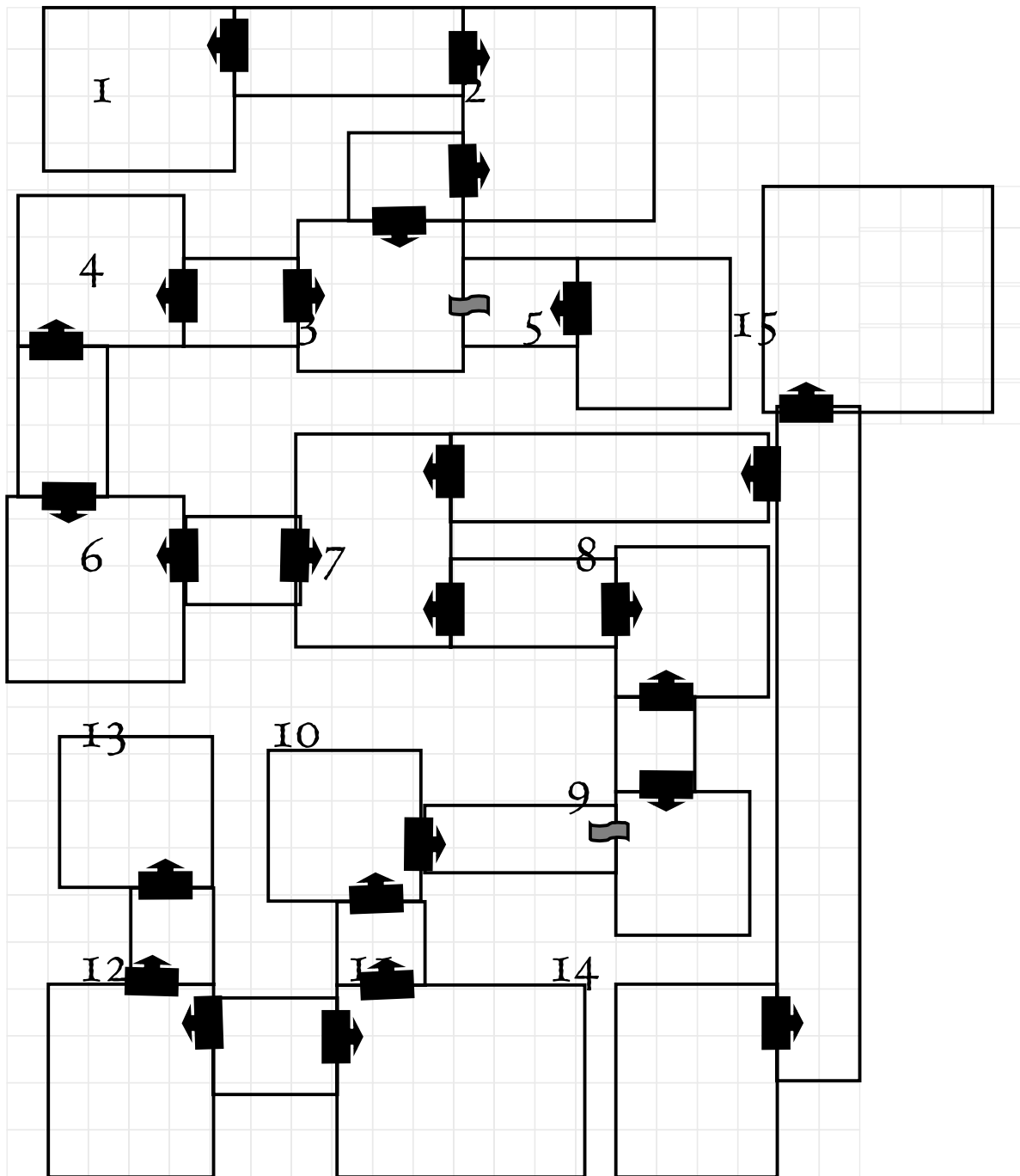

# DM's Map #2

Scale 1 inch = 10 yards

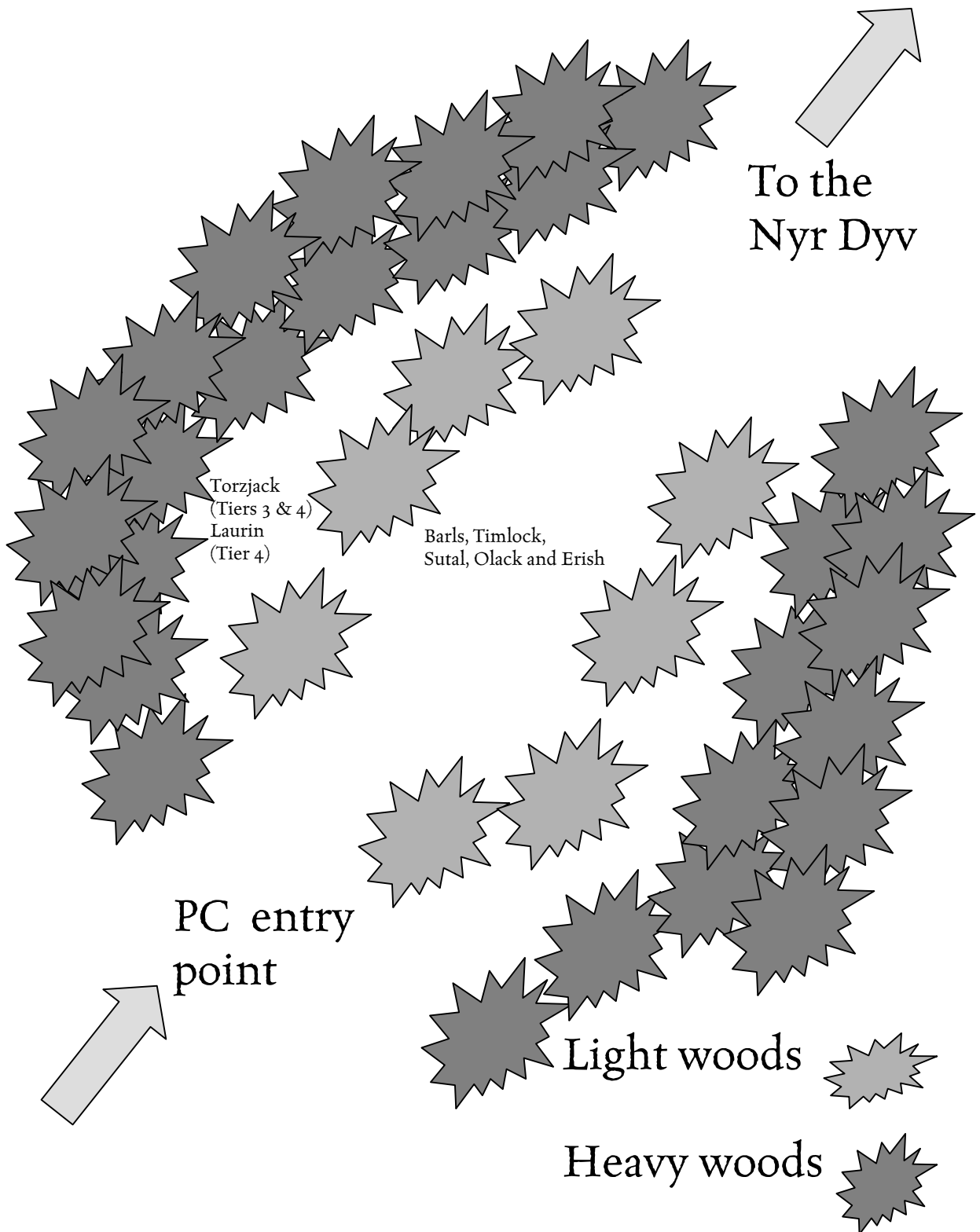



## PLAYER HANDOUT #1

(Notes about the dig)

*This is very unusual. The dig looks as if it has been disturbed. While we have found a few trinkets, there has not been nearly what we had hoped to find. Halston left to fulfill an obligation at the monastery. When he returns, we will let the "guests" see what we've done thus far. Hopefully then we can delve further into the dig and find something truly noteworthy.*

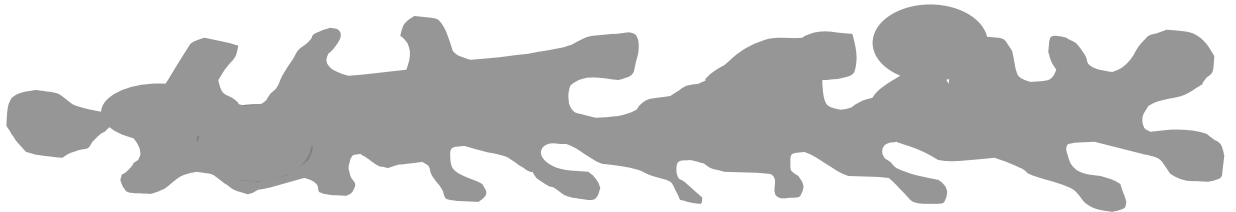

*We have catalogued nearly everything we have found so far. While we promised Halston that we would wait for him, we don't want to sit on our hands and waste valuable time either. Patience is a virtue though, and we shall wait.*

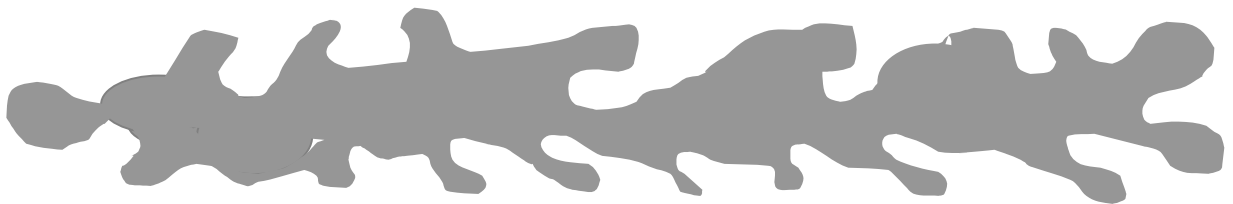

*My other colleagues are quite restless and have decided to go on without Halston and without me if I decide to wait here. I'm sorry, but I'm going onward too. We'll just have more to thrill our "guests" when they've finally arrived. Halston probably got to talking and lost track of time.*

## ENLISTING THE ICONIC

☞ **Tordek, male dwarf Ftr1:** CR 1; Medium-size humanoid (dwarf); HD 1d10+3; hp 13; Init +1; Spd 15 ft.; AC 17 (touch 11, flat-footed 16); Atks +4 melee (1d10+2/x3, dwarven waraxe), or +2 ranged (1d6/x3, shortbow); SQ Dwarven traits; AL LN; SV Fort +5, Ref +1, Will +1; Str 15, Dex 13, Con 16, Int 10, Wis 12, Cha 6.

*Skills and Feats:* Climb +0, Jump +0; Exotic Weapon Proficiency (dwarven waraxe), Weapon Focus (dwarven waraxe).

*Possessions:* Traveler's outfit, scale mail, large wooden shield, dwarven waraxe, shortbow, quiver with 20 arrows, backpack with waterskin, 1 day trail rations, bedroll, sack and flint and steel.

☞ **Mialee, female elf Wizr:** CR 1; Medium-size humanoid (elf); HD 1d4+3; hp 7; Init +3; Spd 30 ft.; AC 13 (touch 13, flat-footed 10); Atks +0 melee (1d6, quarterstaff), or -6 melee (1d6, quarterstaff) and -10 melee (1d6, quarterstaff), or +3 ranged (1d6/x3, shortbow); SQ Elven traits; AL N; SV Fort +0, Ref +3, Will +3; Str 10, Dex 16, Con 10, Int 15, Wis 13, Cha 8.

*Skills and Feats:* Concentration +4, Knowledge (arcane) +6, Listen +3, Search +6, Spellcraft +6, Spot +3; Scribe Scroll (virtual), Toughness.

*Spells Prepared* (3/2; base DC = 12 + spell level): 0—*daze, ray of frost, read magic*; 1<sup>st</sup>—*mage armor, sleep*.

*Spellbook:* 0—all of them; 1<sup>st</sup>—*charm person, mage armor, magic missile, sleep, summon monster I*.

*Possessions:* Traveler's outfit, quarterstaff, shortbow, quiver of 20 arrows, backpack with waterskin, 1 day trail rations, bedroll, sack, flint and steel, 10 candles, map case, 3 pages parchment, ink and pen, spell pouch, spellbook.

☞ **Lidda, female halfling Rogr:** CR 1; Small humanoid (halfling); HD 1d6+1; hp 7; Init +7; Spd 20 ft.; AC 16 (touch 14, flat-footed 13); Atks +1 melee (1d6/19-20, short sword) or +4 ranged (1d8/19-20, light crossbow), or +1 melee (1d4/19-20, dagger) or +5 ranged (1d4/19-20, dagger); SA Sneak attack +1d6; SQ Halfling traits; AL CG; SV Fort +2, Ref +6, Will +1; Str 10, Dex 17, Con 13, Int 14, Wis 10, Cha 8.

*Skills and Feats:* Climb +6, Disable Device +6, Gather Information +1, Hide +11, Jump +6, Listen +6, Move Silently +9, Open Locks +7, Search +6, Spot +4, Tumble +7, Use Magic Device +1; Improved Initiative.

*Possessions:* Explorer's outfit, leather armor, shortsword, light crossbow, 10 crossbow bolts, dagger, Backpack with waterskin, 1 day trail rations, bedroll, sack, flint and steel, thieves' tools hooded lantern, 3 pints of lantern oil.

☞ **Jozan, male human Clr1:** CR 1; Medium-size humanoid (human); HD 1d8+2; hp 10; Init -1; Spd 20 ft.; AC 15 (touch 9, flat-footed 15); Atk +1 melee (1d8+1, heavy mace), or -1 ranged (1d8/19-20, light crossbow); SA Turn Undead 4/day 2d6+2; AL NG; SV Fort +4, Ref -1; Will +4; Str 12, Dex 8, Con 14, Int 10, Wis 15, Cha 13.

*Skills and Feats:* Concentration +6, Heal +6, Listen +4, Knowledge (religion) +0, Spellcraft +4, Spot +4; Alertness, Scribe Scroll.

*Spells Prepared* (3/2+1; base DC 12 + spell level); 0—*detect poison, guidance, read magic*; 1<sup>st</sup>—*bles, protection from evil\**, *shield of faith*.

\* Domain spell; *Deity:* Pelor; *Domains:* Good (good spells cast at +1 caster level) and Healing (healing spells cast at +1 caster level).

*Possessions:* Cleric's vestments, scale mail, large wooden shield, heavy mace, light crossbow, 10 crossbow bolts, backpack with waterskin, 1 day of trail rations, bedroll, sack, flint and steel, wooden holy symbol (sun disk of Pelor), 3 torches.